



INSTRUCTIONS

J03989

2016-06-28



ROAD TECH XM SATELLITE RADIO RECEIVER KIT

GENERAL

Kit Number

76390-05A

Models

For model fitment information, see the P&A retail catalog or the Parts and Accessories section of www.harley-davidson.com (English only).

This kit **IS NOT** compatible with:

- Auxiliary Accessory Switch Housing Kits (left side), Part No. 70213-02A or 70248-02.
- Hand lever bracket clamp-mounted clock (Part No. 75041-03 or 75042-03), OR thermometer (Part No. 75102-04 or 75104-04), when mounted on the **clutch lever** bracket.
- Road Tech™ Quest™ GPS Cruising Mount Kit, Part No. 92300-06.

Additional Parts Required

NOTE

XM satellite radio service is available within the continental United States. It is not available in Alaska or Hawaii.

An XM satellite radio subscription is required, for an additional monthly fee.

2011 and Later Softail, 2012 and Later Dyna and 2014 and Later Sportster models require separate purchase of an Electrical Connection Harness (Part No. 72673-11).

2014 and 2016 Touring require separate purchase of an Electrical Connection Kit (Part No. 69200722).

2017 and Later Touring require separate purchase of an Electrical Connection Kit (Part No. 69201599).

The Road Tech XM Satellite Radio Receiver requires an additional device for audio output. Audio output can be provided by:

- Any Harley-Davidson fairing-mounted radio.
- A Road Tech Riser Mount Radio.
- The Road Tech Stereo Headset (Part No. 76530-07).

These items are available separately from a Harley-Davidson dealer.

⚠ WARNING

Rider and passenger safety depend upon the correct installation of this kit. Use the appropriate service manual procedures. If the procedure is not within your capabilities or you do not have the correct tools, have a Harley-Davidson dealer perform the installation. Improper installation of this kit could result in death or serious injury. (00333b)

NOTE

This instruction sheet refers to service manual information. A service manual for this year/model motorcycle is required for this installation and is available from a Harley-Davidson dealer.

Electrical Overload

NOTICE

It is possible to overload the vehicle's charging system by adding too many electrical accessories. If the combined electrical accessories operating at any one time consume more electrical current than the vehicle's charging system can produce, the electrical consumption can discharge the battery and cause damage to the vehicle's electrical system. (00211d)

⚠ WARNING

When installing any electrical accessory, be certain not to exceed the maximum amperage rating of the fuse or circuit breaker protecting the affected circuit being modified. Exceeding the maximum amperage can lead to electrical failures, which could result in death or serious injury. (00310a)

The Road Tech XM Satellite Radio Receiver requires up to **260 milliamps** additional current from the electrical system.

Kit Contents

See Table 1 and Figure 12.

PREPARATION

NOTE

For vehicles equipped with security siren:

- Verify that the Hands-Free Fob is present.
- Turn the ignition key switch to IGNITION.

Refer to the service manual and follow the instructions to remove the main fuse.



For EFI Models:

▲ WARNING

To prevent spray of fuel, purge system of high-pressure fuel before supply line is disconnected. Gasoline is extremely flammable and highly explosive, which could result in death or serious injury. (00275a)

Follow service manual instructions to purge the fuel supply of high pressure gasoline and remove the fuel supply line.

For Vehicles With Main Fuse:

▲ WARNING

To prevent accidental vehicle start-up, which could cause death or serious injury, remove main fuse before proceeding. (00251b)

1. Refer to the service manual and follow the instructions to remove the main fuse. Remove and retain the seat and all mounting hardware.

For Vehicles With Main Circuit Breaker:

▲ WARNING

To prevent accidental vehicle start-up, which could cause death or serious injury, disconnect negative (-) battery cable before proceeding. (00048a)

1. Refer to the service manual and follow the instructions to remove the seat and disconnect the negative (black) battery cable from the negative (-) battery terminal. Retain all seat mounting hardware.

For Carbureted Models:

▲ WARNING

Gasoline can drain from the carburetor fuel line when disconnected from fuel valve fitting. Gasoline is extremely flammable and highly explosive, which could result in death or serious injury. Wipe up spilled fuel immediately and dispose of rags in a suitable manner. (00256a)

1. Turn the fuel supply valve to OFF. Remove the fuel line from the valve.

For ALL Models:

▲ WARNING

When servicing the fuel system, do not smoke or allow open flame or sparks in the vicinity. Gasoline is extremely flammable and highly explosive, which could result in death or serious injury. (00330a)

1. Follow the instructions in the service manual to remove the instrument console (if equipped) from the fuel tank.
2. See the correct section (Carbureted or EFI Engine) of the service manual for fuel tank removal instructions.

Receiver Mounting Bracket Installation

NOTE

Do not use solvent-based chemicals or waxes directly on the plastic or rubber components as they can affect the overall performance and appearance of the plastic and rubber.

1. Remove the two screws that retain the clutch lever clamp to the handlebar.
2. See Figure 12. Obtain the correct mounting bracket (2) for the vehicle, and two button-head screws (3) and spacers (4) from the kit. Insert the button-head screws into the mounting bracket, through the holes above and below the slot. Place a spacer over the threads of each screw. Insert the screw threads into the holes in the clutch lever clamp removed in Step 1.
3. Adjust the hand lever position for rider comfort, then tighten to 6.8–8 N·m (60–71 in-lbs).

Antenna Bracket and Receiver Installation

1. Obtain the satellite radio receiver (1), antenna bracket (6), and four lock nuts (8) from the kit. Insert the four studs on the back of the receiver through the four holes in the receiver mounting bracket.
2. See Figure 12 for mounted position of the antenna bracket to the receiver mounting bracket. Assemble a lock nut to each of the bottom two studs. Install the antenna bracket onto the top two studs, and assemble a lock nut to each top stud. Tighten the locknuts securely.

Antenna Installation

1. Obtain the XM radio antenna (5) and two-sided adhesive tape (7) from the kit.
2. Use isopropyl alcohol to clean the horizontal antenna mounting surface of the antenna bracket, and the bottom (mounting) surface of the antenna.
3. Peel the liner from one side of the tape, and apply the tape squarely to the bottom surface of the antenna.
4. Peel the liner from the exposed side of the adhesive tape on the antenna base.
5. Position the antenna over the bracket without touching the adhesive to the bracket. Center the antenna over the bracket with the antenna cable toward the center of the vehicle.
6. Press the antenna squarely and firmly onto the bracket, and hold pressure for about 60 seconds. After releasing pressure, avoid direct contact with the antenna for about 20 minutes.

HARNES ROUTING

NOTE

Route the satellite radio receiver harness along the outside of the handlebar, even on internally-wired handlebars.

Route the unconnected end of the satellite radio receiver harness as follows:

1. Follow the existing wiring from the left-side handlebar switches over to the center of the handlebar. Temporarily bind the harness in place as you route the harness along the handlebar to the center. Do not permanently fasten the harness to the handlebar at this time.

- Route the wires down through the upper fork bracket (triple clamp), past the steering head, and back along the frame backbone toward the seat. Follow existing wiring where practical. **For FLHT, FLHTC, FLHTCU, FLHX models**, it may be necessary to remove the inner fairing cap to secure the wires.

HARNESS CONNECTION - GENERAL

Splicing of wire leads is necessary in the installation of the Road Tech XM Satellite Radio Receiver to the motorcycle. Find the instructions for a specific model in the sections that follow, and refer to the service manual appendix for proper wire splicing procedures.

▲ WARNING

Be sure to follow manufacturer's instructions when using the UltraTorch UT-100 or any other radiant heating device. Failure to follow manufacturer's instructions can cause a fire, which could result in death or serious injury. (00335a)

- Avoid directing heat toward any fuel system component. Extreme heat can cause fuel ignition/explosion resulting in death or serious injury.
- Avoid directing heat toward any electrical system component other than the connectors on which heat shrink work is being performed.
- Always keep hands away from tool tip area and heat shrink attachment.
- The Data Link Connector (DLC) [91A] location is different for year/model.

For 2011 and Later Softail Models:

See the next section.

For ALL OTHER Models:

Proceed to **BLACK LEAD CONNECTION** for the specific model.

HARNESS CONNECTION

2011 and Later Softail, 2012 and Later Dyna, and 2014 and Later Sportster Models

NOTE

Requires separate purchase of Electrical Connection Harness (H-D Part No. 72673-11).

- Locate the DLC [91A] (a gray six-way Deutsch pin connector with a rubber boot) under the seat. Place the Electrical Connection Harness at [91A], but **DO NOT** connect at this time.
- Route the Satellite Radio Receiver harness wires over to the Electrical Connection Harness. **DO NOT** cut off the in-line fuse holder on the orange/white wire, but cut the wires to a suitable length to easily reach the sealed splice connectors on the Electrical Connection Harness.
- Splice the black satellite receiver wire to the **black** wires in the Electrical Connection Harness.
- Splice the orange/white satellite receiver wire to the **red/yellow** wires in the Electrical Connection Harness.

- Use a heat gun or suitable radiant-heating device to shrink the connector to the wires.
- Use the heat gun or heating device to seal the open end of the sealed splice connector on the **red/blue** wires in the Electrical Connection Harness.
- Remove the rubber boot from [91A]. Cut the boot off of the wires.
- Connect the socket housing of the Electrical Connection Harness to [91A].
- Insert the rubber boot into the open pin connector of the Electrical Connection Harness.
- Loosen or remove the four screws holding the ECM to the mounting bracket. Route the Electrical Connection Harness under the ECM connector. Tighten the four screws to 5.1–6.2 N·m (45–55 **in-lbs**).
- Proceed to the **SATELLITE RECEIVER CONNECTIONS** section.

2014-2016 Touring Models

- Install Electrical Connection Kit (Part No. 69200722) or verify that all components referenced in that kit are installed. Disconnect gray eight-way connector [4A], if connected.
- See service manual for instructions for crimping instructions.
- Strip, crimp and seal **BLACK** wire of harness to **BLACK** wire of this kit.
- Strip, crimp and seal **VIOLET/BLUE** wire of harness to **ORANGE/WHITE** wire of this kit.

NOTE

*Do not remove the sealed cap from the **RED** wire, it is not used for this application.*

- Connect eight-way connectors together.
- Proceed to the **SATELLITE RECEIVER CONNECTIONS** section.

2017-Later Touring Models

- Install Electrical Connection Kit (Part No. 69201599) or verify that all components referenced in that kit are installed. Disconnect gray three-way [4A], if connected.
- See service manual for instructions for crimping instructions.
- Strip, crimp and seal **BLACK** wire of harness to **BLACK** wire of this kit.
- Strip, crimp and seal **VIOLET/BLUE** wire of harness to **ORANGE/WHITE** wire of this kit.

NOTE

*Do not remove the sealed cap from the **RED** wire, it is not used for this application.*

- Connect three-way connectors together.

- Proceed to the **SATELLITE RECEIVER CONNECTIONS** section.

BLACK LEAD CONNECTION TO GROUND

Dyna Models

- Remove the nut from the ground screw, located on the top of the frame, under the seat near the fuel tank.
- Select the correct ring terminal (9 or 10) from the kit to fit the ground screw.
- See Figure 1. Cut the black wire on the satellite receiver wire harness to easily reach the ground location, and crimp the ring terminal to the end of the wire per the Packard crimping tool instructions in the service manual appendix.
- Install the ring terminal to the ground connection, and secure per the torque specification in the service manual.
- Proceed to **For ALL models** in this section.

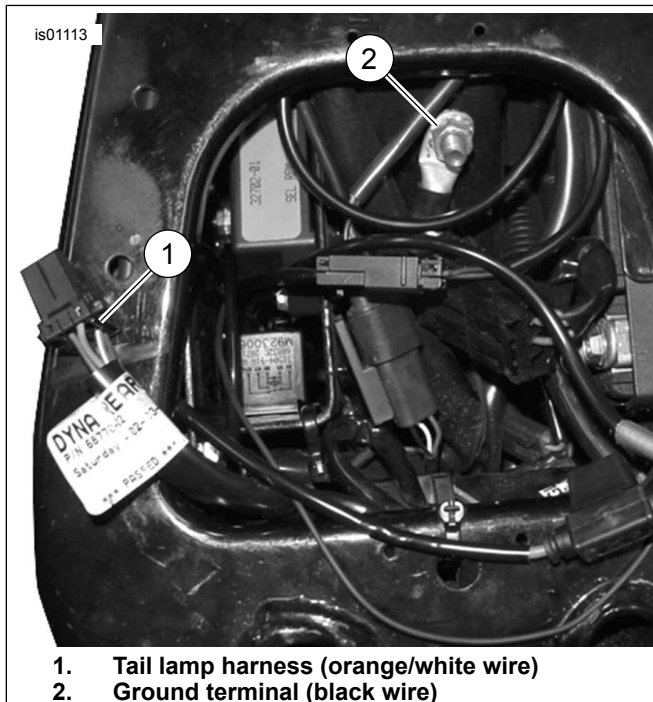

Figure 1. Power and Ground Connections (Dyna Models)

2010 and Earlier Softail Models

- Remove the ground screw, located on the top of the frame, under the seat near the fuel tank.
- Select the correct ring terminal (9 or 10) from the kit to fit the ground screw.
- Cut the black wire on the satellite receiver wire harness to easily reach the ground location, and crimp the ring terminal to the end of the wire per the Packard crimping tool instructions in the service manual appendix.
- See Figure 2. Install the ring terminal onto the ground screw threads. Fasten the ground screw to the frame (2) and secure per the torque specification in the service manual.
- Proceed to **For ALL models** in this section.

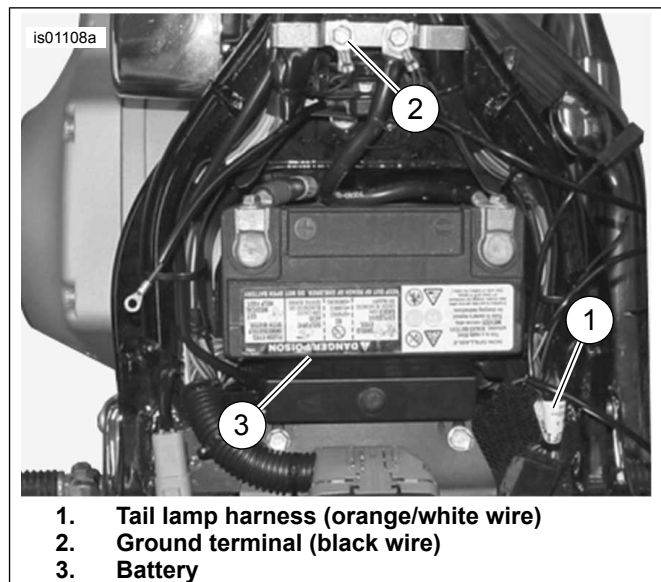

Figure 2. Power and Ground Connections (Softail Models)

2003 and Earlier Touring Models

▲ WARNING

Disconnect negative (-) battery cable first. If positive (+) cable should contact ground with negative (-) cable connected, the resulting sparks can cause a battery explosion, which could result in death or serious injury. (00049a)

- If the negative battery cable **WAS NOT** disconnected at the beginning of the installation, refer to the service manual and follow the instructions to remove the seat and disconnect the negative (black) battery cable from the negative (-) battery terminal. Retain all seat mounting hardware. Then refer to the service manual and follow the instructions to disconnect the positive battery cable.
- Remove the battery from the motorcycle.

NOTE

The black wire should remain long enough so the battery fits into the battery well without stressing or stretching the wire.

- See Figure 3. Cut the black wire on the satellite receiver wire harness to easily reach the ground stud (2) located below the circuit breaker in the battery well under the seat.
- Select the correct ring terminal (9 or 10) from the kit to fit the ground stud.
- Crimp the ring terminal to the end of the wire per the Packard crimping tool instructions in the service manual appendix.
- Install the ring terminal to the ground stud, and secure per the torque specification in the service manual.
- Proceed to **For ALL models** in this section.

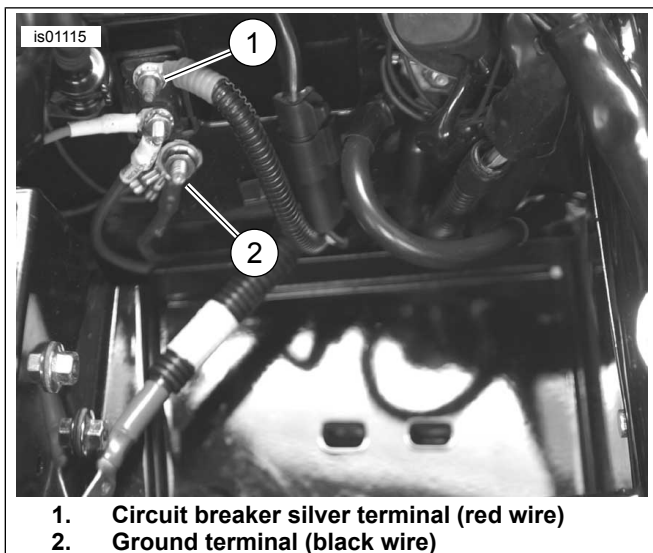

1. Circuit breaker silver terminal (red wire)
2. Ground terminal (black wire)

Figure 3. Connections (With Battery Removed) - 2003 or Earlier Touring Models (2003 FLHTCU shown)

2004 and Later Touring Models

1. Locate the main harness chassis ground stud (there are two, under the seat in front of the battery).
2. Remove the nut from one of the chassis ground studs.
3. Select the correct ring terminal (9 or 10) from the kit to fit the ground stud.
4. Cut the black wire on the satellite receiver wire harness to easily reach the ground location, and crimp the ring terminal to the end of the wire per the Packard crimping tool instructions in the service manual appendix.
5. Install the ring terminal to the ground connection, and secure per the torque specification in the service manual.
6. Proceed to **For ALL models** in this section.

For ALL models

Check to be sure there is sufficient slack in the black lead so that handlebar movement will not be restricted.

Proceed to the **ORANGE/WHITE LEAD CONNECTION** section for the specific model.

ORANGE/WHITE LEAD CONNECTION TO SWITCHED POWER SOURCE

Use the service manual wiring diagrams for a specific model and year vehicle to locate a power source that is fed through the ignition switch.

2003 and Earlier Dyna Models

The satellite receiver **switched** power source is an orange/white (O/W) main harness power lead inside the electrical side cover.

1. Remove the electrical side cover, located on the left side of the motorcycle near the battery.
2. See Figure 1. Carefully slice open an area of the main harness wrap inside the side cover at an accessible point, and cut an orange/white main harness power lead.

3. Cut the excess length from the orange/white power lead **of the satellite receiver wire harness** to within easy reach of the cut orange/white wires inside the side cover, but DO NOT cut off the in-line fuse holder.
4. See Figure 12. Obtain a blue sealed splice connector (13) from the kit. See Figure 4, the 2 into 1 splice configuration. Splice the satellite receiver wire harness power lead to the main harness orange/white wires per the instructions in the service manual appendix.
5. Proceed to **For ALL models** in this section.

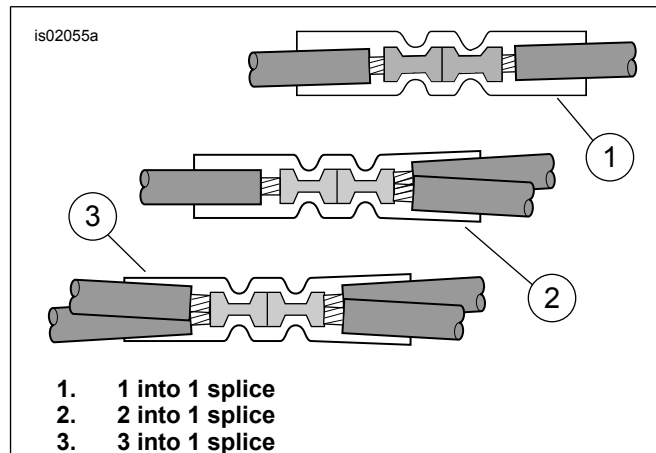

Figure 4. Splice Configurations

2004-2011 Dyna Models

The satellite receiver **switched** power source is an open fuse position on the fuse panel. See the FUSES section of the service manual and the correct wiring diagram in the service manual appendix.

1. Remove the electrical side cover, located on the left side of the motorcycle near the battery, by firmly grasping both sides and pulling outward.
2. Remove the electrical panel from the vehicle per service manual instructions.
3. See Figure 12. Obtain the orange/white fuse block adapter wire (11) from the kit. Note the terminal on each end (see Figure 5). Only the terminal with the spring tabs will fit into this fuse block. Carefully cut the unused terminal from the wire and discard it.
4. See Figure 6. Locate the fuse cavity (1) labeled "OPEN" on the electrical caddy. There is a terminal in only one side of this cavity. From the back side, insert the terminal on the orange/white adapter wire into the open side of the cavity until it stops. Refer to a nearby factory-installed terminal for comparison to verify proper orientation and depth.
5. Cut the excess length from the orange/white power lead **of the satellite receiver wire harness** to within easy reach of the adapter wire, but DO NOT cut off the in-line fuse holder.
6. See Figure 12. Obtain the red sealed splice connector (12) from the kit. See Figure 4, the 1 into 1 splice configuration. Splice the satellite receiver wire harness power lead to the adapter wire per the instructions in the service manual appendix.
7. See Figure 12. Install a 2A fuse (14) from the kit into the "OPEN" fuse cavity to complete the circuit.

- Install the electrical panel per the instructions in the service manual. Install the electrical panel cover by aligning the pins with the rubber bushings in the electrical panel and pushing firmly into place.
- Proceed to **For ALL models** in this section.

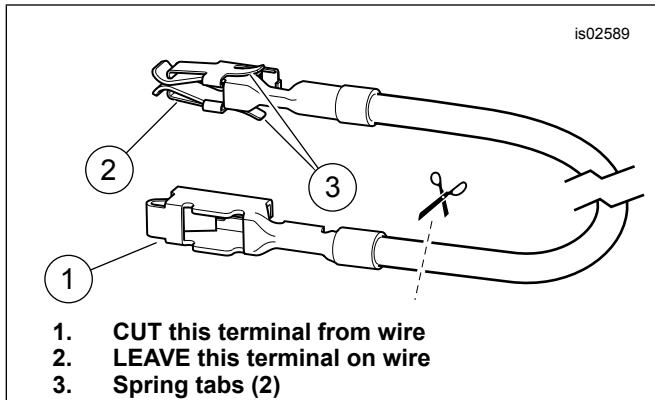

Figure 5. Fuse Block Adapter Wire (Dyna and Softail)

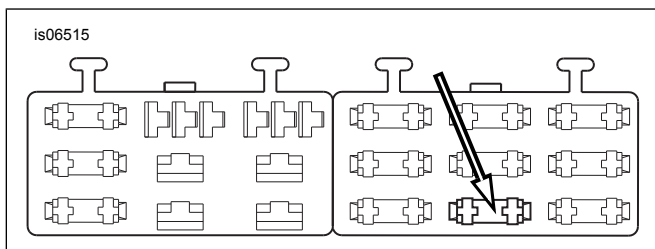

Figure 6. "OPEN" Fuse Block Cavity (2004 and Later Dyna)

2003 and Earlier Softail Models

The satellite receiver **switched** power source is the orange/white (O/W) wire in the tail lamp harness under the seat.

- See Figure 2. Carefully slice open an area of the tail lamp harness (1) wrap at an accessible point under the seat, and cut the orange/white wire.
- Cut the excess length from the orange/white power lead **of the satellite receiver wire harness** to within easy reach of the cut orange/white wires under the seat, but **DO NOT** cut off the in-line fuse holder.
- See Figure 12. Obtain the blue sealed splice connector (13) from the kit. See Figure 4, the 2 into 1 splice configuration. Splice the satellite receiver wire harness power lead to the cut orange/white wires per the instructions in the service manual appendix.
- Proceed to **For ALL models** in this section.

2004-2010 Softail Models

The satellite receiver **switched** power source is an open fuse position on the fuse panel. See the FUSES section of the service manual and the correct wiring diagram in the service manual appendix.

- Remove the fuse block cover. Remove the two hex screws holding the fuse block bracket, and pull the bracket and fuse block assembly from the vehicle frame.
- Press the tab retaining the left fuse block, and slide the block out of the mounting slots.

- See Figure 12. Obtain the orange/white fuse block adapter wire (11) from the kit. Note the terminal on each end (see Figure 5). Only the terminal with the spring tabs will fit into this fuse block. Carefully cut the unused terminal from the wire and discard it.
- See Figure 7. Locate the fuse cavity (1) labeled "P&A IGN" on the fuse block cover. There is a terminal in only one side of this cavity. From the back side, insert the terminal on the orange/white adapter wire into the open side of the cavity until it stops. Refer to a nearby factory installed terminal for comparison to verify proper orientation and depth.
- Cut the excess length from the orange/white power lead **of the satellite receiver wire harness** to within easy reach of the adapter wire, but **DO NOT** cut off the in-line fuse holder.
- See Figure 12. Obtain the red sealed splice connector (12) from the kit. See Figure 4, the 1 into 1 splice configuration. Splice the satellite receiver wire harness power lead to the adapter wire per the instructions in the service manual appendix.
- See Figure 12. Install a 2A fuse (14) from the kit into the "P&A IGN" fuse cavity to complete the circuit.
- Slide the fuse block into the mounting slots in the fuse block bracket until it clicks firmly into place. Install the bracket and fuse block assembly into position and fasten with the hex screws removed earlier. Tighten securely.
- Proceed to **For ALL models** in this section.

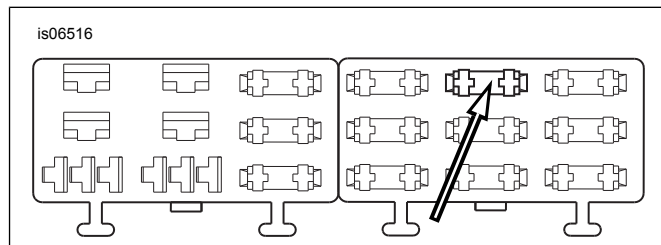
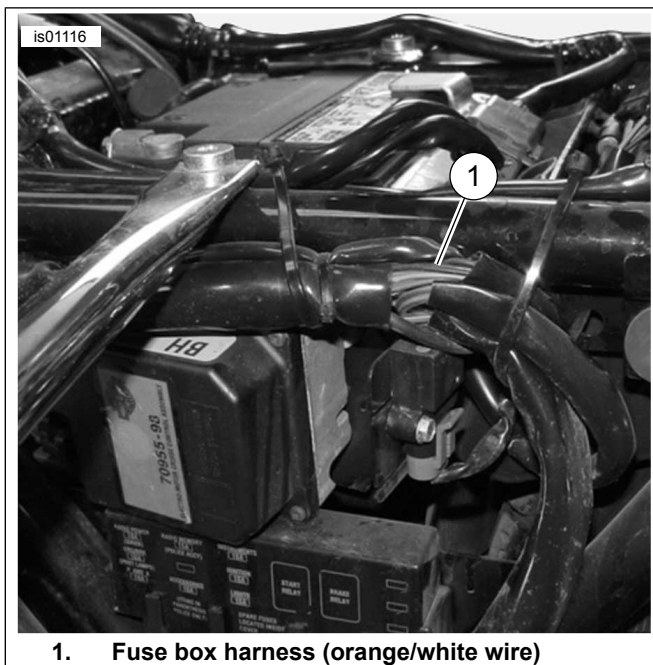

Figure 7. "P&A IGN" Fuse Block Cavity (2004-2010 Softail)

2003 and Earlier Touring Models

The satellite receiver **switched** power source is an orange/white (O/W) main harness power lead inside the right side cover, near the top.

- See Figure 8. Carefully slice open an area of the main harness wrap inside the electrical side cover at an accessible point, and cut an orange/white main harness power lead.



1. Fuse box harness (orange/white wire)

Figure 8. Fuse Box Harness Behind Left-Hand Side Cover, 2003 or Earlier Touring Models (FLHTCUI Shown)

2. Cut the excess length from the orange/white power lead of the satellite receiver wire harness to within easy reach of the cut orange/white wires inside the side cover, but DO NOT cut off the in-line fuse holder.
3. See Figure 12. Obtain the blue sealed splice connector (13) from the kit. See Figure 4, the 2 into 1 splice configuration. Splice the satellite receiver wire harness power lead to the main harness orange/white wires per the instructions in the service manual appendix.
4. Proceed to **For ALL models** in this section.

2004-2007 Touring Models

The satellite receiver **switched** power source is an open fuse position on the fuse panel. See the FUSES section of the service manual and the correct wiring diagram in the service manual appendix.

1. **For 2004-2006 models:** Remove the left side cover per service manual instructions to access the fuse box. **For 2007 models:** Remove the right side cover per service manual instructions to access the fuse box. **For 2004-2007 models:** Remove the main fuse holder, fuse block and dust cover from the vehicle per service manual instructions.
2. Obtain the orange/white fuse block adapter wire (11) from the kit. **For 2004 through 2006 models:** Note the terminal on each end (see Figure 9, **upper view**). Only the terminal **WITHOUT** the spring tabs will fit into the fuse cavity. Carefully cut the terminal **WITH** spring tabs from the wire and discard it. **For 2007 models:** Note the terminal on each end (see Figure 9, **lower view**). Only the terminal **WITH** the spring tabs will fit into the fuse cavity. Carefully cut the terminal **WITHOUT** spring tabs from the wire and discard it.

3. **2004-2007 models:** See Figure 10. Locate the fuse cavity marked "P&A IGN", "2A MAX" (1). There is a terminal in only one side of this cavity. Remove the three fuses (2) currently installed in this row, noting their location.
4. Gently remove the orange plastic secondary lock from the fuse block. Insert the terminal on the orange/white adapter wire into the open side of the cavity until it stops. Refer to a nearby factory installed terminal for comparison to verify proper orientation and depth. Install the secondary lock.
5. Install the three fuses removed in Step 3.
6. See Figure 12. Cut the excess length from the orange/white satellite receiver harness wire. Using the red sealed splice connector (12) from the kit, splice that wire to the adapter wire installed in Step 4.
7. Install the 2A fuse (14) from the kit into the fuse cavity marked "P&A IGN", "2A MAX" to complete the circuit.
8. Proceed to **For ALL models** in this section.

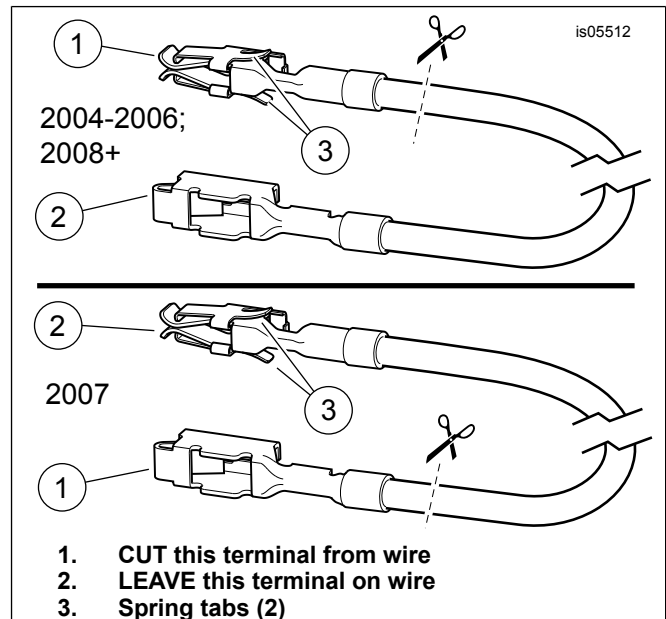

Figure 9. Fuse Block Adapter Wire (FL Touring)

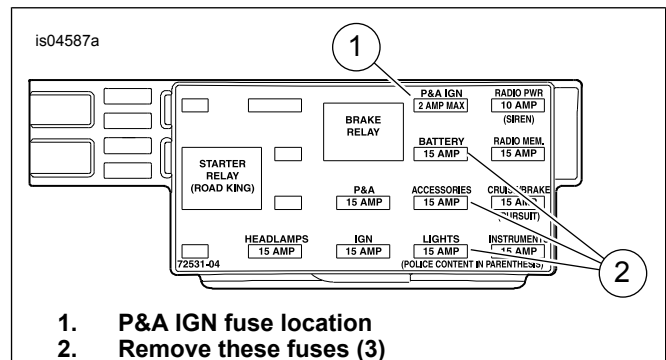

Figure 10. P&A IGN Fuse Cavity (2004-2007 Touring Models)

2008 and Later Touring Models

The satellite receiver **switched** power source is an open fuse position on the fuse panel. See the FUSES section of the service manual and the correct wiring diagram in the service manual appendix.

1. Remove the left side cover per service manual instructions to access the fuse box. Remove the left-side electrical caddy from the vehicle, and remove the fuse blocks from the back of the caddy per service manual instructions.
2. Obtain the orange/white fuse block adapter wire (11) from the kit. Note the terminal on each end (see Figure 10, **upper view**). Only the terminal **WITH the spring tabs** will fit into the fuse cavity. Carefully cut the terminal **WITHOUT** spring tabs from the wire and discard it.
3. See Figure 11. Locate fuse cavity 1A-1B (marked "P&A IGN", "2A MAX" on the cover) on the lower fuse block (1). Remove the brake relay (2) and fuse (3, if present) currently installed in column A-B, noting their location.
4. Gently remove the orange plastic secondary lock from column A-B. Insert the terminal on the orange/white adapter wire into the empty cavity until it stops. Refer to a nearby factory installed terminal for comparison to verify proper orientation and depth. Install the secondary lock.
5. Install the relay (and fuse, if equipped) removed in Step 3.
6. See Figure 12. Cut the excess length from the orange/white satellite receiver harness wire. Using the red sealed splice connector (12) from the kit, splice that wire to the adapter wire installed in Step 4.
7. Install the 2A fuse (14) from the kit into fuse cavity 1A-1B (4) to complete the circuit.
8. Proceed to **For ALL models** in this section.

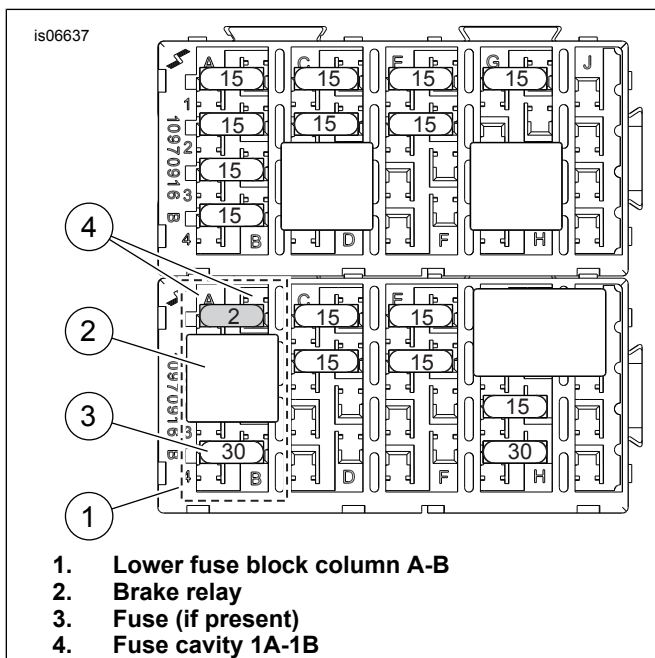

Figure 11. P&A IGN Fuse Cavity (2008 and Later Touring Models)

For ALL models

1. Check to be sure there is sufficient slack in the orange/white lead so that handlebar movement will not be restricted.
2. Use cable straps (15) and adhesive-backed clips (16) from the kit to fasten the satellite receiver harness wires to the frame or harnesses along the vehicle frame backbone. Check to verify that the harness wires do not pull tight when the handlebars are turned fully to the left or right fork stops.

3. Open the cover of the fuse holder (A) on the satellite receiver harness. Plug the remaining 2 Amp fuse (14) from the kit into the fuse holder, and close the cover.
4. Check along the entire length of the wiring for rubbing, chafing or pinch points. Proceed to the next section.

SATELLITE RECEIVER CONNECTIONS

Satellite Receiver Connection to Vehicle Radio

1. Locate the jack wire on the satellite receiver harness. Route the 3.5 mm stereo jack (B) to the AUX-in port on the face of the vehicle radio.
2. Remove the rubber plug cover from the AUX-in port. Plug the satellite receiver jack into the AUX-in port on the radio.

NOTE

On FLHT models, when installing the satellite receiver jack to the radio AUX-in port,

- roll back the outer lip of the rubber seal,
- install the jack plug into the radio port,
- gently roll the seal back to its original shape to form a seal over the radio port.

This will help eliminate "spring-back" of the plug out of the socket.

Satellite Antenna Connection to Satellite Receiver

1. Fold the antenna cable in half.
2. Insert the connector (D) on the antenna cable into the mating connector on the back of the XM satellite receiver.
3. Route the antenna cable down the handlebar alongside the satellite receiver harness.

▲ WARNING

Be sure that steering is smooth and free without interference. Interference with steering could result in loss of vehicle control and death or serious injury. (00371a)

- Be sure wires do not pull tight when handlebars are turned fully to left or right fork stops.
6. Use cable straps (15) and adhesive-backed clips (16) from the kit as necessary to fasten the satellite receiver harness, jack wire and antenna cable to the handlebar. Check to verify that the harness wires do not pull tight when the handlebars are turned fully to the left or right fork stops.

FINAL ASSEMBLY

NOTE

Verify that the ignition key switch is in the OFF position **before** installing the main fuse or attaching the battery cables.

▲ WARNING

Connect positive (+) battery cable first. If positive (+) cable should contact ground with negative (-) cable connected, the resulting sparks can cause a battery explosion, which could result in death or serious injury. (00068a)

1. **For 2003 and earlier Touring models only:** Refer to the service manual and follow the instructions to attach the battery cables (positive cable first). Apply a light coat of Harley-Davidson electrical contact lubricant (H-D Part No. 99861-02), petroleum jelly or corrosion retardant material to the battery terminals. **For ALL OTHER models: Models with main fuse:** Refer to the service manual and follow the instructions to install the main fuse. **Models with main circuit breaker:** Refer to the service manual and follow the instructions to attach the negative battery cable. Apply a light coat of Harley-Davidson electrical contact lubricant (H-D Part No. 99861-02), petroleum jelly or corrosion retardant material to the negative battery terminal.

NOTE

For FLHT, FLHTC, FLHTCU, FLHX models. If the inner fairing cap was removed, it should be installed at this time.

For ALL models:

▲ WARNING

When servicing the fuel system, do not smoke or allow open flame or sparks in the vicinity. Gasoline is extremely flammable and highly explosive, which could result in death or serious injury. (00330a)

1. Install the fuel tank per service manual instructions.
2. Install the handlebar cover, riser cover or outer fairing, if equipped, per service manual instructions.
3. Turn the ignition key switch to ON, but do not start the motorcycle. See the XM satellite receiver owner's manual for detailed operating procedures. Test the receiver and the rest of the sound system for proper operation.

▲ WARNING

After installing seat, pull upward on seat to be sure it is locked in position. While riding, a loose seat can shift causing loss of control, which could result in death or serious injury. (00070b)

4. Refer to the service manual, and follow instructions to install the seat.

NOTE

Do not use solvent-based chemicals or waxes directly on the plastic or rubber components as they can affect the overall performance and appearance of the plastic and rubber.

OPTIONAL AUTOMOTIVE INSTALLATION

The Road Tech XM Satellite Radio Receiver can also be mounted in an automobile or truck, using components of this kit AND the following items, available separately:

NOTE

Some local governments prohibit or restrict the use of suction mounts on the windshield or windows of a motor vehicle. Check with local authorities and obey all applicable laws and regulations. Other dashboard or friction mounting options are available.

- An automotive mounting bracket, various styles available from the xm radio store (shop.xmradio.com).
- An audio adapter (cassette adapter or FM modulator) for the vehicle radio.
- A female-to-female 3.5 mm stereo jack adapter, to connect the XM receiver to the audio adapter.
- An automotive XM satellite radio antenna.

NOTE

Make certain the installed mount does not block the vehicle operator's view of driving conditions.

Make certain the cable path does not interfere with the operation of vehicle controls and safety equipment.

Do not mount over airbag panels or in front of an airbag field of deployment.

1. Install the automotive mounting bracket (purchased separately) per the manufacturer's instructions.
2. Disconnect the mating electrical plugs (C) on the XM receiver harness to separate the satellite radio receiver (1) from the motorcycle wiring. Remove the four lock nuts (8) that mount the satellite radio receiver (1) to the mounting bracket (2) on the motorcycle.
3. Obtain the automotive mount adapter (17) from **this** kit.

NOTE

When installing the lock nuts, some friction resistance should be observed, indicating that the Nylon locking rings are still effective. If no resistance is felt, the lock nuts should be replaced.

4. With the narrow end of the mounting slot pointing UP, secure the automotive mount adapter to the back of the satellite receiver with the four lock nuts. Tighten securely.
5. Obtain the automotive adapter harness (18) from **this** kit. Connect the mating plug from the adapter harness to the satellite radio receiver harness.
6. Use a female-to-female 3.5 mm stereo jack adapter (purchased separately) to connect the audio output connection of the XM receiver to an automotive audio adapter (cassette adapter or FM modulator, also purchased separately) according to the manufacturer's instructions.
7. Install an automotive XM satellite radio antenna (purchased separately) per the manufacturer's instructions.
8. Connect the terminal end of the antenna to the mating socket connection on the back of the XM receiver.
9. Plug the free end of the automotive adapter harness into an available 12/24 Volt DC power receptacle (cigarette lighter or power point) in the vehicle. Use care when routing the cable to verify that it does not interfere with vehicle operation in any way.
10. See the XM satellite receiver owner's manual for detailed operating procedures.

WARRANTY

Road Tech XM Satellite Radio Receiver Warranty

This product is warranted against all defects in material and workmanship for a period of 90 days from the date of purchase.

When installed by an authorized Harley-Davidson dealer the product is covered by a 1-year warranty. When installed by an authorized Harley-Davidson dealer at the time of delivery of a new vehicle and registered to the vehicle, the product is covered by a 2-year warranty.

This product is warranted through Harley-Davidson. See an authorized Harley-Davidson dealer for warranty and service issues.

Dealers Only

Follow normal Harley-Davidson warranty claim procedures.

SERVICE PARTS

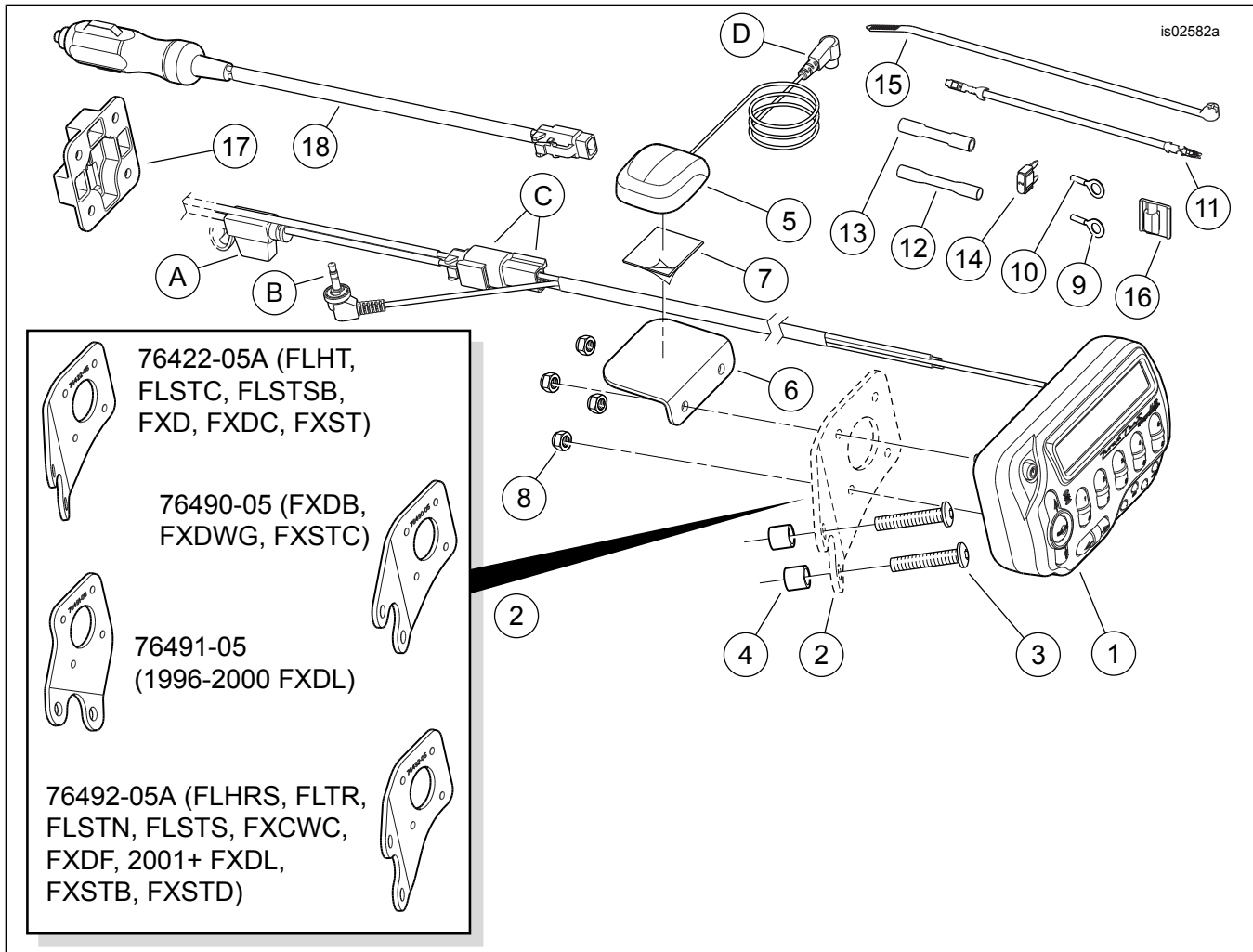

Figure 12. Service Parts, Road Tech XM Satellite Radio Kit

SERVICE PARTS

Table 1. Service Parts

Item	Description (Quantity)	Part Number
1	XM satellite radio receiver assembly	Not sold separately
2	Bracket, satellite radio receiver support (Dyna models FXD, FXDC)	76422-05A
	Bracket, satellite radio receiver support (Dyna models FXDB, FXDWG)	76490-05
	Bracket, satellite radio receiver support (Dyna model FXDF)	76492-05A
	Bracket, satellite radio receiver support (Dyna model FXDL, 1996-2000)	76491-05
	Bracket, satellite radio receiver support (Dyna model FXDL, 2001 and later)	76492-05A
	Bracket, satellite radio receiver support (Softail models FLSTC, FLSTSB, FXST)	76422-05A
	Bracket, satellite radio receiver support (Softail models FLSTS, FLSTN)	76492-05A
	Bracket, satellite radio receiver support (Softail models FXCWC, FXSTB, FXSTD)	76492-05A
	Bracket, satellite radio receiver support (Softail model FXSTC)	76490-05
	Bracket, satellite radio receiver support (Touring model FLHT)	76422-05A
	Bracket, satellite radio receiver support (Touring models FLHRS, FLTR)	76492-05A
3	Cap screw, button head, 1/4-20 x 38 mm (1½ in) long (2)	2519
4	Spacer (2)	5854

Table 1. Service Parts

Item	Description (Quantity)	Part Number
5	XM radio antenna	76395-05
6	Bracket, antenna	76391-05
7	Adhesive tape, two-sided	Not sold separately
8	Nut, Nylock, #8-32 (4)	7864
9	Ring terminal, #18-22 AWG (1/4 in. stud)	9858
10	Ring terminal, #18-22 AWG (5/16 in. stud)	9859
11	Fuse block adapter wire	70329-04
12	Sealed splice connector, #18-20 AWG (red)	70585-93
13	Sealed splice connector, #14-16 AWG (blue)	70586-93
14	Fuse, blade type, 2A (2)	54305-98
15	Cable strap (10)	10006
16	Clip, adhesive-backed (3)	10271
17	Adapter, automotive mount	76499-05
18	Harness, automotive adapter	76500-05
Items mentioned in text, but not included in kit:		
A	Fuse holder on the satellite receiver harness	
B	3.5 mm stereo jack on the satellite receiver harness	
C	Mating plugs on the satellite receiver harness	
D	Antenna cable connector	