



INSTRUCTIONS

J05151

2010-05-11



ROAD TECH ZUMO GLOBAL POSITIONING SYSTEM (GPS) CHROME HANDLEBAR MOUNT KIT

GENERAL

Kit Numbers

76000022

Models

This kit is required when using a Road Tech™ Zumo 660® or Zumo 665 GPS unit on specific model motorcycles.

For model fitment information, see the P&A retail catalog or the Parts and Accessories section of www.harley-davidson.com (English only).

This kit **IS NOT** compatible with:

- Auxiliary accessory switch housing kits (left side) (Part No. 70213-02C or 70248-02B).
- Hand lever bracket clamp-mounted clock (Part No. 75041-03 or 75042-03), OR thermometer (Part No. 75102-04 or 75104-04), when mounted on the **clutch lever** bracket.
- The Road Tech™ XM Satellite Radio Receiver Kit (Part No. 76390-05A).

NOTE

XM satellite radio is available within the continental United States. It is not available in Alaska or Hawaii. An XM satellite radio subscription is required, for an additional fee.

Additional Parts Required

Either a Road Tech Zumo 660 GPS Kit (Part No. 92115-09) or a Road Tech Zumo 665 GPS Kit (Part No. 76000014) is required. These items are available from a Harley-Davidson dealer.

2004 and later XL (Sportster) models will require separate purchase of a Hand Control Clamp Screw Service Kit (Part No. 42320-04A) to attach the GPS mounting bracket to the clutch lever clamp.

2011 and later Softail models will require separate purchase of an Electrical Connection Harness (H-D Part No. 72673-11).

Tools and Supplies Required

An UltraTorch UT-100 (HD-39969), Robinair Heat Gun (HD-25070) with Heatshrink Attachment (HD-41183), or other suitable radiant heating device is required for the proper installation of this kit.

Installation of this kit will also require the use of a terminal crimping tool, and other parts and supplies. Electrical Contact Lube (H-D Part No. 99861-02) or equivalent is required after battery cable disconnection. These items are available from a Harley-Davidson dealer.

▲ WARNING

Rider and passenger safety depend upon the correct installation of this kit. Use the appropriate service manual procedures. If the procedure is not within your capabilities or you do not have the correct tools, have a Harley-Davidson dealer perform the installation. Improper installation of this kit could result in death or serious injury. (00333b)

NOTE

This instruction sheet refers to service manual information. A service manual for this year/model motorcycle is required for this installation and is available from a Harley-Davidson dealer.

Electrical Overload

NOTICE

It is possible to overload the vehicle's charging system by adding too many electrical accessories. If the combined electrical accessories operating at any one time consume more electrical current than the vehicle's charging system can produce, the electrical consumption can discharge the battery and cause damage to the vehicle's electrical system. (00211d)

▲ WARNING

When installing any electrical accessory, be certain not to exceed the maximum amperage rating of the fuse or circuit breaker protecting the affected circuit being modified. Exceeding the maximum amperage can lead to electrical failures, which could result in death or serious injury. (00310a)

Both the Road Tech Zumo 660 and 665 require up to **2.0A** additional current from the electrical system.

Service Parts

See Figure 16 and Table 1.

PREPARATION

NOTE

For vehicles equipped with security siren:

- Verify that the Hands-Free Fob is present.
- Turn the ignition key switch to **IGNITION**.

For VRSC models only: Remove the air box aluminum cover per service manual instructions.

Refer to the service manual and follow the instructions to remove the main fuse.

For EFI models EXCEPT VRSC:



⚠ WARNING

To prevent spray of fuel, purge system of high-pressure fuel before supply line is disconnected. Gasoline is extremely flammable and highly explosive, which could result in death or serious injury. (00275a)

Follow service manual instructions to purge the fuel supply of high pressure gasoline and remove the fuel supply line.

For vehicles with main fuse:

⚠ WARNING

To prevent accidental vehicle start-up, which could cause death or serious injury, remove main fuse before proceeding. (00251b)

1. Refer to the service manual and follow the instructions to remove the main fuse. Remove and retain the seat and all mounting hardware.

For vehicles with main circuit breaker:

⚠ WARNING

To prevent accidental vehicle start-up, which could cause death or serious injury, disconnect negative (-) battery cable before proceeding. (00048a)

1. Refer to the service manual and follow the instructions to remove the seat and disconnect the negative (black) battery cable from the negative (-) battery terminal. Retain all seat mounting hardware.

For carbureted models:

⚠ WARNING

Gasoline can drain from the carburetor fuel line when disconnected from fuel valve fitting. Gasoline is extremely flammable and highly explosive, which could result in death or serious injury. Wipe up spilled fuel immediately and dispose of rags in a suitable manner. (00256a)

2. Turn the fuel supply valve to OFF. Remove the fuel line from the valve.

For ALL models EXCEPT VRSC:

⚠ WARNING

When servicing the fuel system, do not smoke or allow open flame or sparks in the vicinity. Gasoline is extremely flammable and highly explosive, which could result in death or serious injury. (00330a)

3. Follow the instructions in the service manual to remove the instrument console (if equipped) from the fuel tank.
4. See the correct section (Carbureted or EFI Engine) of the service manual for fuel tank removal instructions.

MOUNTING BRACKET AND PLATE INSTALLATION

For ALL Models:

NOTE

Do not use solvent-based chemicals or waxes directly on the plastic or rubber components as they can affect the overall performance and appearance of the plastic and rubber.

1. See Figure 16. Get the GPS mounting bracket (1) from the kit. **ALL models EXCEPT 2004 and later XL (Sportster):** Also get two 1/4-20 x 28.6 mm (1 1/8 in) long screws (2) from the kit. **2004 and later Sportster models:** Also get a Hand Control Clamp Screw Service Kit (Part No. 42320-04, purchased separately).
2. **For ALL models:** Remove and discard the original equipment (OE) clutch lever clamp mounting screws and clamp.
3. Insert the **new** screws into the GPS mounting bracket. Insert the screw threads through the holes in the clutch lever housing.
4. Adjust the hand lever position for rider comfort, then tighten the screws to 6.8–9 N·m (60–80 **in-lbs**).
5. Obtain the mounting plate (7), upper ball clamp (5) and three flat head screws (6) from the kit.
6. Insert the screws into the mounting plate and upper ball clamp as shown. Place the upper ball clamp over the mounting ball, lining up the holes with those in the lower ball clamp. Thread the screws into the lower ball clamp, position the mounting plate to a suitable viewing angle and tighten the screws to 4–6.8 N·m (36–60 **in-lbs**).

CRADLE MOUNT INSTALLATION

1. Obtain the cradle mount (A) from the Road Tech Zumo 660 or 665 GPS Kit, and four button head screws (8) from **this** kit.
2. Position the cradle mount to the mounting plate (7) with the power harness exiting to the right. Insert a button head screw through one of the holes in the cradle and into the corresponding threaded hole in the mounting plate, but do not fully tighten.
3. Insert three button head screws through the remaining holes in the cradle and into the mounting plate holes. Alternately tighten the four screws to 1.58–2.26 N·m (14–20 **in-lbs**).

HARNESS ROUTING

NOTE

Route the Zumo power harness along the outside of the handlebar, even on internally-wired handlebars.

1. Route the unconnected end of the harness as follows:
 - a. Follow the existing wiring from the left-side handlebar switches over to the center of the handlebar. Use cable straps (19) from the kit to tie the harness in place as the harness is routed along the handlebar to the center. For some models, removal of a handlebar cover, instruments or other accessory items may be necessary. Refer to the service manual or accessory instructions as needed.

NOTE

For some VRSC models, it may be necessary to loosen or remove the headlamp or instrument panel shroud to access the wiring path.

2. Follow the existing wiring to route the Zumo power harness:
 - through, across or around the upper fork clamp (triple tree),
 - along the motorcycle frame,
 - to a general location under the seat.
- **For VRSC models only:** Route the red wire near the battery positive (+) terminal, located toward the front right side of the frame.
3. Use cable straps (19) from the kit to fasten the Zumo power harness to the wire harnesses along the vehicle frame.

HARNESS CONNECTION - GENERAL

Splicing of wire leads is necessary in the installation of the Zumo handlebar mount to the motorcycle. Find the instructions for a specific model in the sections that follow, and refer to the service manual appendix for proper wire splicing procedures.

▲ WARNING

Be sure to follow manufacturer's instructions when using the UltraTorch UT-100 or any other radiant heating device. Failure to follow manufacturer's instructions can cause a fire, which could result in death or serious injury. (00335a)

- Avoid directing heat toward any fuel system component. Extreme heat can cause fuel ignition/explosion resulting in death or serious injury.
- Avoid directing heat toward any electrical system component other than the connectors on which heat shrink work is being performed.
- Always keep hands away from tool tip area and heat shrink attachment.

For 2011 and later Softail models: See the next section.

For ALL OTHER models: Proceed to **BLACK LEAD CONNECTION** for the specific model.

HARNESS CONNECTION - 2011 AND LATER SOFTAIL MODELS

NOTE

Requires separate purchase of Electrical Connection Harness (H-D Part No. 72673-11).

1. Locate the Digital Technician connector [91A] (a gray six-way Deutsch pin connector with a rubber boot) under the seat. Place the Electrical Connection Harness at connector [91A], but DO NOT connect at this time.
2. Route the Zumo power harness wires over to the Electrical Connection Harness. DO NOT cut off the in-line fuse holder on the red wire, but cut the wires to a suitable length to easily reach the sealed splice connectors on the Electrical Connection Harness.
3. Splice the black Zumo wire to the **black** wires in the Electrical Connection Harness.

4. Splice the red Zumo wire to the **red/yellow** wires in the Electrical Connection Harness.
5. Use a heat gun or suitable radiant-heating device to shrink the connector to the wires.
6. Use the heat gun or heating device to seal the open end of the sealed splice connector on the **red/blue** wires in the Electrical Connection Harness.
7. Pull the rubber boot out from the gray Digital Technician pin connector [91A]. Cut the boot off of the wires.
8. Connect the socket housing of the Electrical Connection Harness to connector [91A].
9. Insert the rubber boot into the open pin connector of the Electrical Connection Harness.
10. Loosen or remove the four screws holding the ECM to the mounting bracket. Route the Electrical Connection Harness under the ECM connector. Tighten the four screws to 5.1–6.2 N·m (45–55 in·lbs).
11. Proceed to the **RETURN TO SERVICE** section.

BLACK LEAD CONNECTION TO GROUND

Dyna Models

1. Remove the nut from the ground screw, located on the top of the frame, under the seat near the fuel tank.
2. Select the correct ring terminal (13 or 14) from the kit to fit the ground screw.
3. See Figure 1. Cut the black wire on the Zumo wire harness to easily reach the ground location, and crimp the ring terminal to the end of the wire per the Packard crimping tool instructions in the service manual appendix.
4. Install the ring terminal to the ground connection, and secure per the torque specification in the service manual.
5. Proceed to **For ALL models** in this section.

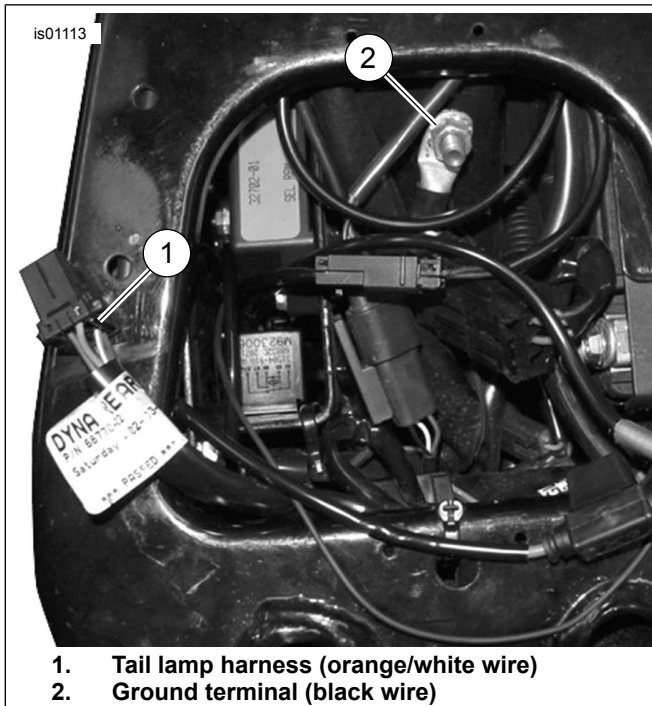

Figure 1. Power and Ground Connections (Dyna Models)

2010 and Earlier Softail Models

1. Remove the ground screw, located on the top of the frame, under the seat near the fuel tank.
2. Select the correct ring terminal (13 or 14) from the kit to fit the ground screw.
3. Cut the black wire on the Zumo wire harness to easily reach the ground location, and crimp the ring terminal to the end of the wire per the Packard crimping tool instructions in the service manual appendix.
4. See Figure 2. Install the ring terminal onto the ground screw threads. Fasten the ground screw to the frame (2) and secure per the torque specification in the service manual.
5. Proceed to **For ALL models** in this section.

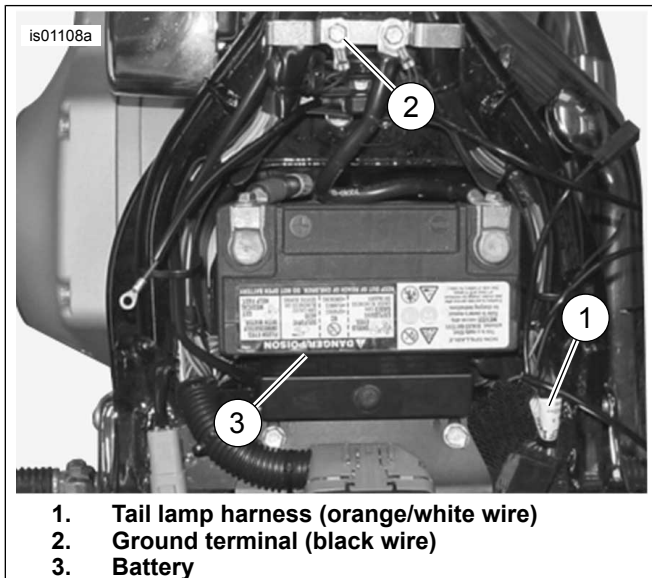
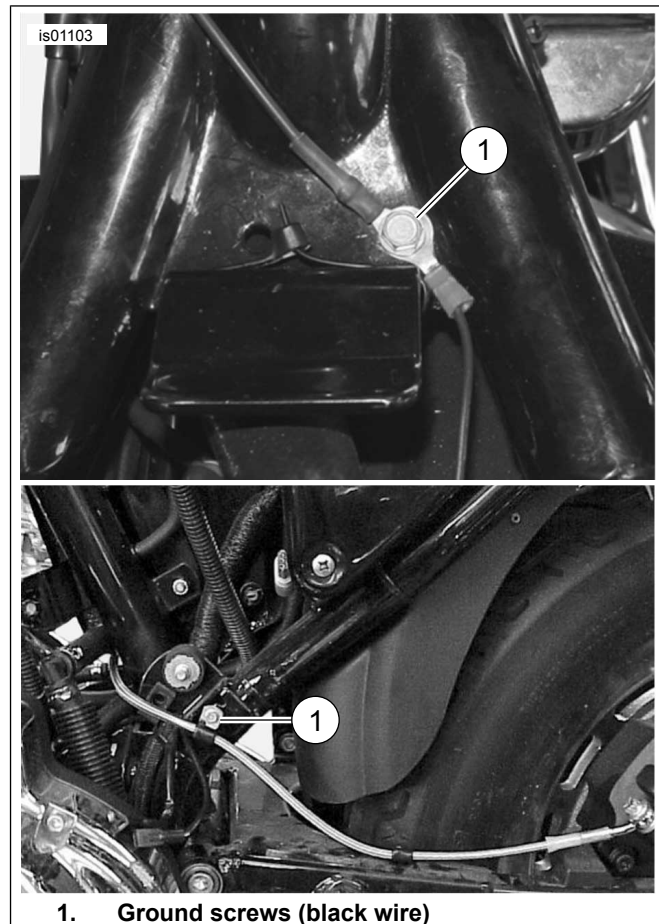

Figure 2. Power and Ground Connections (Softail Models)

Sportster Models

1. Remove the electrical side cover, located on the left side of the motorcycle near the battery.
2. Route the Zumo wire harness through the top of the frame under the seat to the circuit breaker located on the inside of the electrical side cover.
3. See Figure 3. Remove the ground screw (1), located:
 - under the seat on some 1996-2003 models, or
 - near the swingarm on 1995 or earlier models, and 1996-2003 models without a screw under the seat.
 - on the engine near the starter on 2004 and later models.
4. Select the correct ring terminal (13 or 14) from the kit to fit the ground screw.
5. Cut the black wire on the Zumo wire harness to easily reach the ground location, and crimp the ring terminal to the end of the wire per the Packard crimping tool instructions in the service manual appendix.
6. Install the ring terminal onto the ground screw threads. Fasten the ground screw at the original location, and secure per the torque specification in the service manual.
7. Proceed to **For ALL models** in this section.



1. Ground screws (black wire)

Figure 3. Ground Connections (Sportster Models)

2003 and Earlier Touring Models

⚠ WARNING

Disconnect negative (-) battery cable first. If positive (+) cable should contact ground with negative (-) cable connected, the resulting sparks can cause a battery explosion, which could result in death or serious injury. (00049a)

1. If the negative battery cable **WAS NOT** disconnected at the beginning of the installation, refer to the service manual and follow the instructions to remove the seat and disconnect the negative (black) battery cable from the negative (-) battery terminal. Retain all seat mounting hardware. Then refer to the service manual and follow the instructions to disconnect the positive battery cable.
2. Remove the battery from the motorcycle.

NOTE

The black wire should remain long enough so the battery fits into the battery well without stressing or stretching the wire.

3. See Figure 4. Cut the black wire on the Zumo wire harness to easily reach the ground stud (2) located below the circuit breaker in the battery well under the seat.
4. Select the correct ring terminal (13 or 14) from the kit to fit the ground stud.
5. Crimp the ring terminal to the end of the wire per the Packard crimping tool instructions in the service manual appendix.
6. Install the ring terminal to the ground stud, and secure per the torque specification in the service manual.
7. Proceed to **For ALL models** in this section.

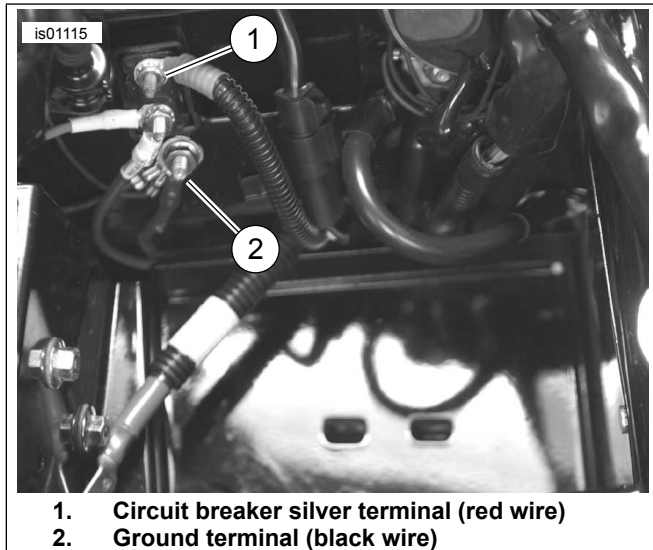

Figure 4. Connections (with battery removed) - 2003 or Earlier Touring Models (2003 FLHTCU shown)

2004 and Later Touring Models

1. Locate the main harness chassis ground stud (there are two, under the seat in front of the battery).
2. Remove the nut from one of the chassis ground studs.
3. Select the correct ring terminal (13 or 14) from the kit to fit the ground stud.

4. Cut the black wire on the Zumo wire harness to easily reach the ground location, and crimp the ring terminal to the end of the wire per the Packard crimping tool instructions in the service manual appendix.
5. Install the ring terminal to the ground connection, and secure per the torque specification in the service manual.
6. Proceed to **For ALL models** in this section.

2006 and Earlier V-Rod Models

1. See Figure 5. Remove the screw (1, under the seat) that fastens the ignition switch (2) to the right side of the frame.
2. Scrape the paint from the top of the frame where the screw was removed, to make a strong ground contact.
3. Select the correct ring terminal (13 or 14) from the kit to fit the ignition switch screw.
4. Cut the black wire on the Zumo wire harness to easily reach the ground location, and crimp the ring terminal to the end of the wire per the Packard crimping tool instructions in the service manual appendix.
5. Install the black wire ring terminal onto the threads of the ignition switch screw. Install the screw to the ignition switch and tighten to 6–10 N·m (53–88 in-lbs).
6. Proceed to **For ALL models** in this section.

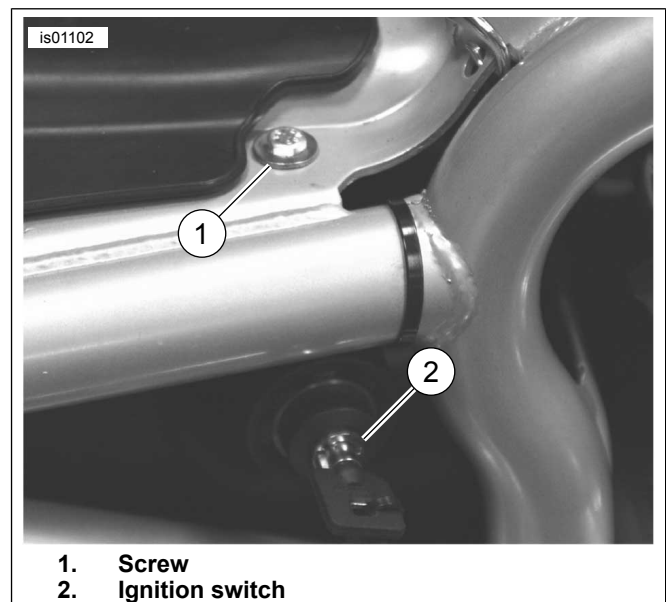

Figure 5. Ground Connection (2006 and Earlier V-Rod Models)

2007 and Later V-Rod Models

The Zumo harness **black** wire connects directly to the battery negative terminal.

1. Select the correct ring terminal (13 or 14) from the kit to fit the negative terminal fastener on the battery.

2. Cut the Zumo harness black wire to within easy reach of the battery negative terminal. Crimp the ring terminal to the end of the black wire per the Packard crimping tool instructions in the service manual appendix.
3. Fasten the black wire ring terminal to the negative terminal mounting post on the battery. Tighten the terminal fastener to 7–10 N·m (60–96 in-lbs).

For ALL models

Check to be sure there is sufficient slack in the black lead so that handlebar movement will not be restricted.

Proceed to the **RED LEAD CONNECTION** section for the specific model.

RED LEAD CONNECTION TO SWITCHED POWER SOURCE

Use the service manual wiring diagrams for a specific model and year vehicle to locate a power source that is fed through the ignition switch.

2003 and Earlier Dyna Models

The Zumo **switched** power source is an orange/white (O/W) main harness power lead inside the electrical side cover.

1. Remove the electrical side cover, located on the left side of the motorcycle near the battery.
2. See Figure 1. Carefully slice open an area of the main harness wrap inside the side cover at an accessible point, and cut an orange/white main harness power lead.
3. Cut the excess length from the red power lead **of the Zumo wire harness** to within easy reach of the cut orange/white wires inside the side cover, but DO NOT cut off the in-line fuse holder.
4. See Figure 16. Obtain a sealed splice connector (3) from the kit. See Figure 6, the 2 into 1 splice configuration. Splice the Zumo wire harness power lead to the main harness orange/white wires per the instructions in the service manual appendix.
5. Proceed to **For ALL models** in this section.

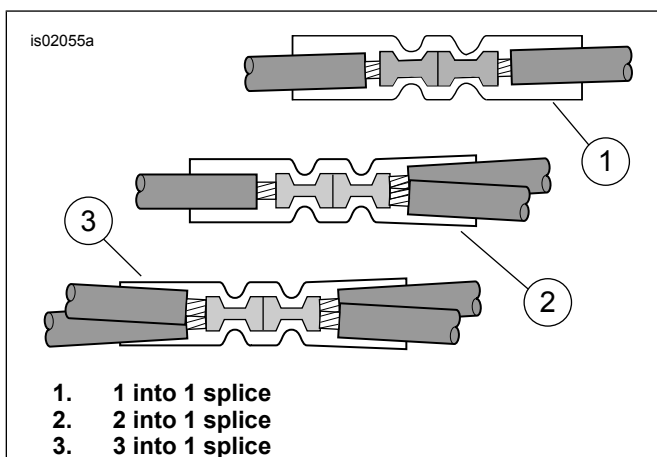

Figure 6. Splice Configurations

2004 and Later Dyna Models

The Zumo **switched** power source is an open fuse position on the fuse panel. See the FUSES section of the service manual and the correct wiring diagram in the service manual appendix.

1. Remove the electrical side cover, located on the left side of the motorcycle near the battery, by firmly grasping both sides and pulling outward.
2. Remove the electrical panel from the vehicle per service manual instructions.
3. See Figure 16. Obtain the orange/white fuse block adapter wire (15) from the kit. Note the terminal on each end (see Figure 7). Only the terminal with the spring tabs will fit into this fuse block. Carefully cut the unused terminal from the wire and discard it.
4. See Figure 8. Locate the fuse cavity (1) indicated as "OPEN" on the fuse block cover in the right fuse block. Insert the terminal on the orange/white adapter wire until it stops. Refer to a nearby factory installed terminal for comparison to verify proper orientation and depth.
5. Cut the excess length from the red power lead **of the Zumo wire harness** to within easy reach of the adapter wire, but DO NOT cut off the in-line fuse holder.
6. See Figure 16. Obtain the blue sealed splice connector (17) from the kit. See Figure 6, the 1 into 1 splice configuration. Splice the Zumo wire harness power lead to the adapter wire per the instructions in the service manual appendix.
7. See Figure 16. Install the 2A fuse (18) from the kit into the "OPEN" fuse cavity to complete the circuit.
8. Install the electrical panel per the instructions in the service manual. Install the electrical panel cover by aligning the pins with the rubber bushings in the electrical panel and pushing firmly into place.
9. Proceed to **For ALL models** in this section.

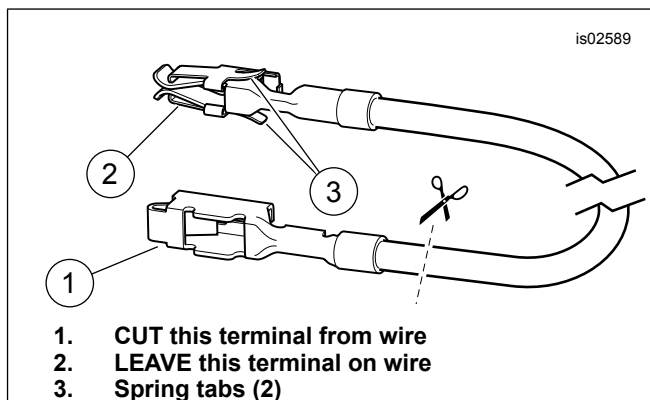

Figure 7. Fuse Block Adapter Wire (Dyna and Softail)

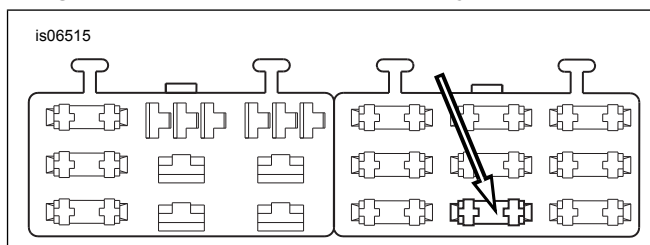

Figure 8. "OPEN" Fuse Block Cavity (2004 and Later Dyna)

2003 and Earlier Softail Models

The Zumo **switched** power source is the orange/white (O/W) wire in the tail lamp harness under the seat.

1. See Figure 2. Carefully slice open an area of the tail lamp harness (1) wrap at an accessible point under the seat, and cut the orange/white wire.
2. Cut the excess length from the red power lead **of the Zumo wire harness** to within easy reach of the cut orange/white wires under the seat, but **DO NOT** cut off the in-line fuse holder.
3. See Figure 16. Obtain the blue sealed splice connector (17) from the kit. See Figure 6, the 2 into 1 splice configuration. Splice the Zumo wire harness power lead to the cut orange/white wires per the instructions in the service manual appendix.
4. Proceed to **For ALL models** in this section.

2004-2010 Softail Models

The Zumo **switched** power source is an open fuse position on the fuse panel. See the FUSES section of the service manual and the correct wiring diagram in the service manual appendix.

1. Remove the fuse block cover. Remove the two hex head screws fastening the fuse block bracket, and pull the bracket and fuse block assembly away from the vehicle frame.
2. Press the tab retaining the left fuse block, and slide the block out of the mounting slots.
3. See Figure 16. Obtain the orange/white fuse block adapter wire (15) from the kit. Note the terminal on each end (see Figure 7). Only the terminal with the spring tabs will fit into this fuse block. Carefully cut the unused terminal from the wire and discard it.
4. See Figure 9. Locate the fuse cavity (1) indicated as "P&A IGN" on the fuse block cover in the right fuse block. Insert the terminal on the orange/white adapter wire until it stops. Refer to a nearby factory installed terminal for comparison to verify proper orientation and depth.
5. Cut the excess length from the red power lead **of the Zumo wire harness** to within easy reach of the adapter wire, but **DO NOT** cut off the in-line fuse holder.
6. See Figure 16. Obtain the blue sealed splice connector (17) from the kit. See Figure 6, the 1 into 1 splice configuration. Splice the Zumo wire harness power lead to the adapter wire per the instructions in the service manual appendix.
7. See Figure 16. Install the 2A fuse (18) from the kit into the "P&A IGN" fuse cavity to complete the circuit.
8. Slide the fuse block into the mounting slots in the fuse block bracket until it clicks firmly into place. Install the bracket and fuse block assembly into position and fasten with the two hex head screws removed earlier. Tighten securely.
9. Proceed to **For ALL models** in this section.

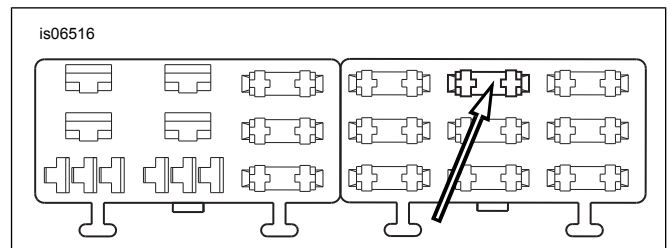
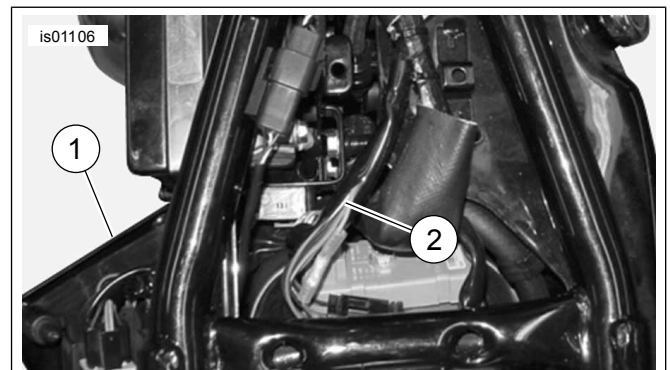

Figure 9. "P&A IGN" Fuse Block Cavity (2004-2010 Softail)

Sportster Models

The Zumo **switched** power source is an orange/white (O/W) main harness power lead inside the electrical side cover or under the seat.

1. See Figure 10. Carefully slice open an area of the main harness wrap inside the electrical side cover or under the seat at an accessible point, and cut an orange/white main harness power lead.



1. **Left side cover containing circuit breaker silver terminal (red wire)**
2. **Stock wire harness (orange/white wire)**

Figure 10. Power Connections (XL Models)

2. Cut the excess length from the red power lead **of the Zumo wire harness** to within easy reach of the cut orange/white wires inside the side cover or under the seat, but **DO NOT** cut off the in-line fuse holder.
3. See Figure 16. Obtain the blue sealed splice connector (17) from the kit. See Figure 6, the 2 into 1 splice configuration. Splice the Zumo wire harness power lead to the main harness orange/white wires per the instructions in the service manual appendix.
4. Proceed to **For ALL models** in this section.

2003 and Earlier Touring Models

The Zumo **switched** power source is an orange/white (O/W) main harness power lead inside the right side cover, near the top.

1. See Figure 11. Carefully slice open an area of the main harness wrap inside the electrical side cover at an accessible point, and cut an orange/white main harness power lead.

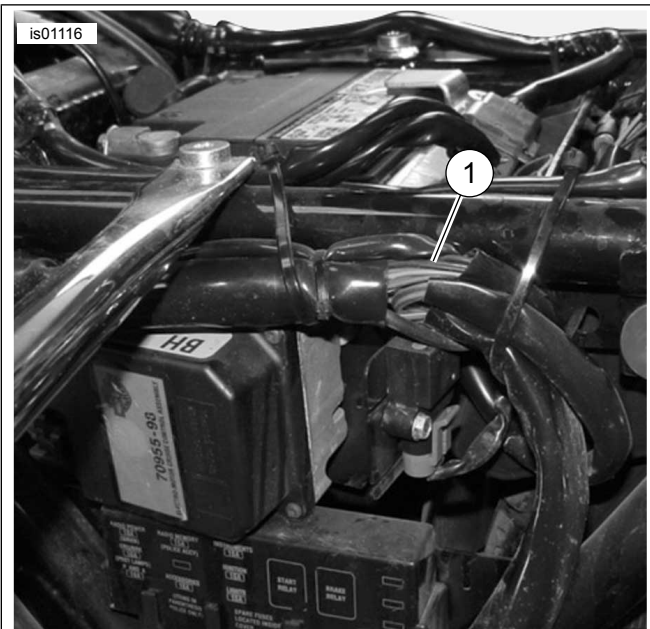

1. Fuse box harness (orange/white wire)

Figure 11. Fuse Box Harness Behind Left-Hand Side Cover, 2003 or Earlier Touring Models (FLHTCUI Shown)

2. Cut the excess length from the red power lead of the Zumo wire harness to within easy reach of the cut orange/white wires inside the side cover, but DO NOT cut off the in-line fuse holder.
3. See Figure 16. Obtain the blue sealed splice connector (17) from the kit. See Figure 6, the 2 into 1 splice configuration. Splice the Zumo wire harness power lead to the main harness orange/white wires per the instructions in the service manual appendix.
4. Proceed to **For ALL models** in this section.

2004-2007 Touring Models

The Zumo **switched** power source is an open fuse position on the fuse panel. See the FUSES section of the service manual and the correct wiring diagram in the service manual appendix.

1. **For 2004-2006 models:** Remove the left side cover per service manual instructions to access the fuse box. **For 2007 models:** Remove the right side cover per service manual instructions to access the fuse box. **For 2004-2007 models:** Remove the main fuse holder, fuse block and dust cover from the vehicle per service manual instructions.
2. Obtain the orange/white fuse block adapter wire (15) from the kit. **For 2004 through 2006 models:** Note the terminal on each end (see Figure 12, upper view). Only the terminal **WITHOUT** the spring tabs will fit into the fuse cavity. Carefully cut the terminal **WITH** spring tabs from the wire and discard it. **For 2007 models:** Note the terminal on each end (see Figure 12, lower view). Only the terminal **WITH** the spring tabs will fit into the fuse cavity. Carefully cut the terminal **WITHOUT** spring tabs from the wire and discard it.
3. **2004-2007 models:** See Figure 13. Locate the fuse cavity marked "P&A IGN", "2A MAX" (1). Remove the three fuses (2) currently installed in this row, noting their location.

4. Gently remove the orange plastic secondary lock from the fuse block. Insert the terminal on the orange/white adapter wire until it stops. Refer to a nearby factory installed terminal for comparison to verify proper orientation and depth. Install the secondary lock.
5. Install the three fuses removed in Step 3.
6. See Figure 16. Cut the excess length from the orange/white Zumo harness wire. Using the blue sealed splice connector (17) from the kit, splice that wire to the adapter wire installed in Step 4.
7. Install the 2A fuse (18) from the kit into the fuse cavity marked "P&A IGN", "2A MAX" to complete the circuit.
8. Proceed to **For ALL models** in this section.

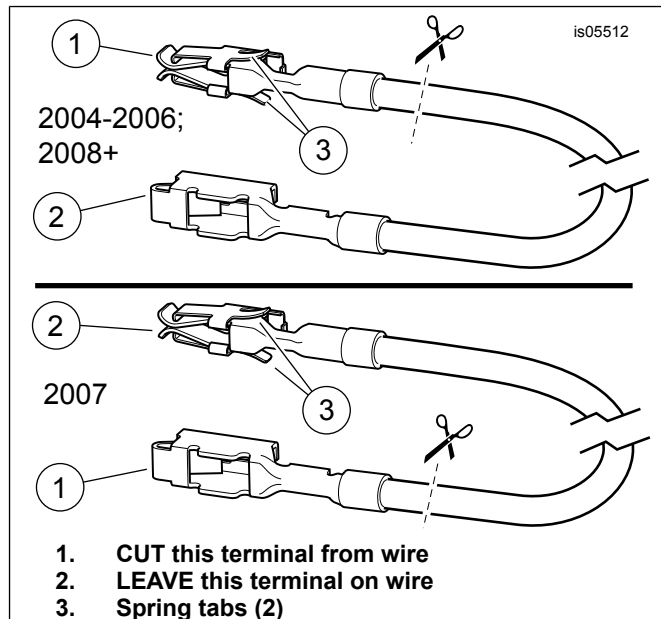
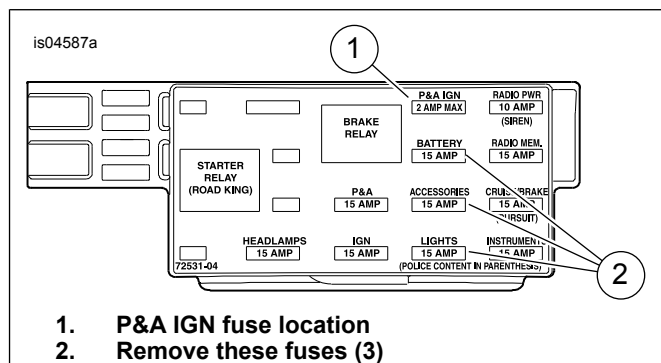

Figure 12. Fuse Block Adapter Wire (FL Touring)



1. P&A IGN fuse location
2. Remove these fuses (3)

Figure 13. P&A IGN Fuse Cavity (2004-2007 Touring Models)

2008 and Later Touring Models

The Zumo **switched** power source is an open fuse position on the fuse panel. See the FUSES section of the service manual and the correct wiring diagram in the service manual appendix.

1. Remove the left side cover per service manual instructions to access the fuse box. Remove the left-side electrical caddy from the vehicle, and remove the fuse blocks from the back of the caddy per service manual instructions.

- Obtain the orange/white fuse block adapter wire (17) from the kit. Note the terminal on each end (see Figure 13, **upper view**). Only the terminal **WITH the spring tabs** will fit into the fuse cavity. Carefully cut the terminal **WITHOUT** spring tabs from the wire and discard it.
- See Figure 14. Locate fuse cavity 1A-1B (marked "P&A IGN", "2A MAX" on the cover) on the lower fuse block (1). Remove the brake relay (2) and fuse (3, if present) currently installed in column A-B, noting their location.
- Gently remove the orange plastic secondary lock from column A-B. Insert the terminal on the orange/white adapter wire into the empty cavity until it stops. Refer to a nearby factory installed terminal for comparison to verify proper orientation and depth. Install the secondary lock.
- Install the relay (and fuse, if equipped) removed in Step 3.
- See Figure 16. Cut the excess length from the orange/white Zumo harness wire. Using the blue sealed splice connector (19) from the kit, splice that wire to the adapter wire installed in Step 4.
- Install the 2A fuse (20) from the kit into fuse cavity 1A-1B (4) to complete the circuit.
- Proceed to **For ALL models** in this section.

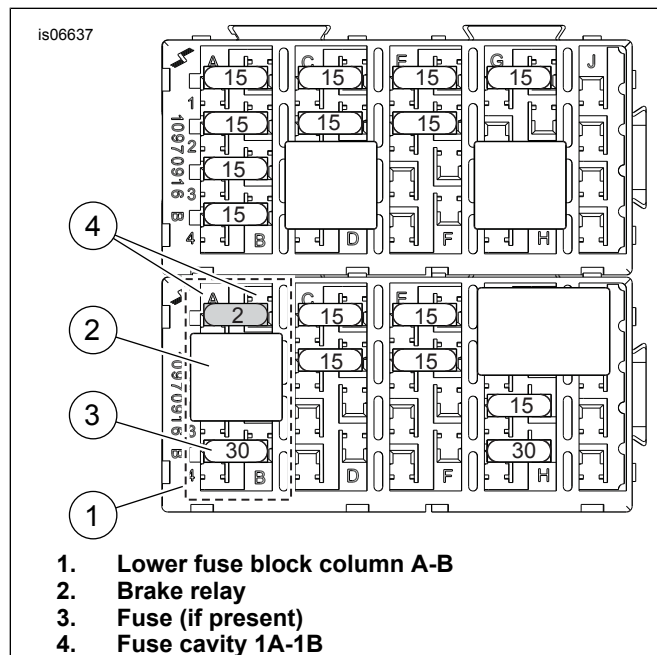

Figure 14. P&A IGN Fuse Cavity (2008 and Later Touring Models)

V-Rod Models

The Zumo **switched** power source is an orange/white (O/W) main harness power lead coming from the fuse block.

- See Figure 15. Carefully slice open an area of the main harness wrap near the fuse block (2) at an accessible point, and cut the orange/white main harness wire leading to the fuse cavity (1) marked:
 - ACCESSORIES on 2002-2006 models, or
 - P&A IGNITION on 2007 and later models.

- Cut the excess length from the red power lead **of the Zumo wire harness** to within easy reach of the cut orange/white wires at the fuse block, but **DO NOT** cut off the in-line fuse holder.
- See Figure 16. Obtain the blue sealed splice connector (17) from the kit. See Figure 6, the 2 into 1 splice configuration. Splice the Zumo wire harness power lead to the main harness orange/white wires per the instructions in the service manual appendix.
- Install the 2A fuse (18) from the kit into the fuse cavity to complete the circuit.

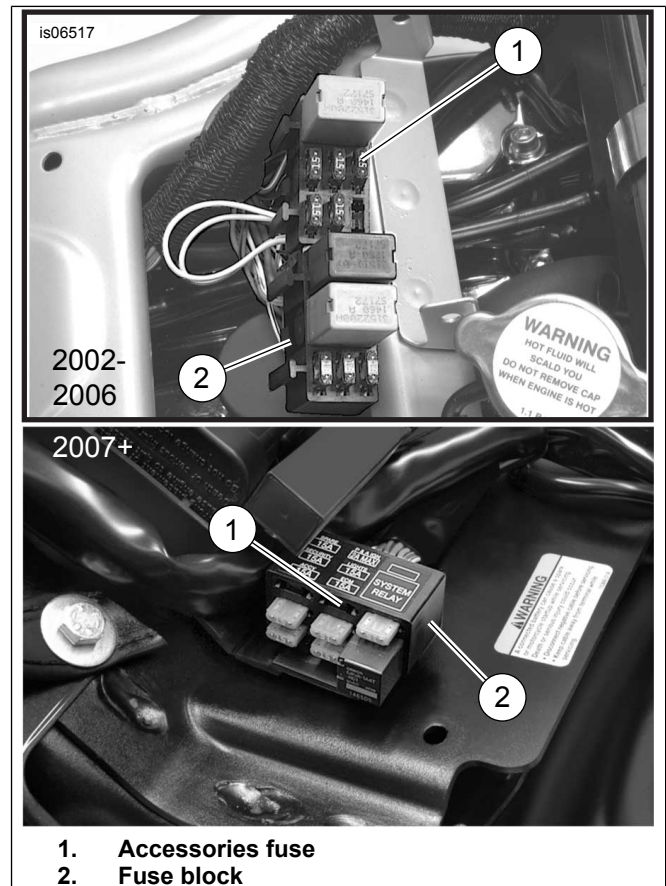

Figure 15. Accessory Fuse Locations (V-Rod Models)

For ALL models

Check to be sure there is sufficient slack in the red lead so that handlebar movement will not be restricted.

Proceed to the next section.

RETURN TO SERVICE

NOTE

DO NOT perform the following steps until the Zumo and all related wiring have been installed per the procedures outlined in this instruction sheet for your model motorcycle.

- Install the Road Tech Zumo GPS unit into the cradle mount per the instructions in the GPS kit.

NOTE

Verify that the ignition key switch is in the OFF position before installing the main fuse or attaching the battery cables.

▲ WARNING

Connect positive (+) battery cable first. If positive (+) cable should contact ground with negative (-) cable connected, the resulting sparks can cause a battery explosion, which could result in death or serious injury. (00068a)

2. **For 2003 and earlier Touring models only:** Refer to the service manual and follow the instructions to attach the battery cables (positive cable first). Apply a light coat of Harley-Davidson electrical contact lubricant (H-D Part No. 99861-02), petroleum jelly or corrosion retardant material to the battery terminals. **For ALL OTHER models: Models with main fuse:** Refer to the service manual and follow the instructions to install the main fuse. **Models with main circuit breaker (EXCEPT Sportster):** Refer to the service manual and follow the instructions to attach the negative battery cable. Apply a light coat of Harley-Davidson electrical contact lubricant (H-D Part No. 99861-02), petroleum jelly or corrosion retardant material to the negative battery terminal. **Sportster models with main circuit breaker:** Refer to the service manual, and follow the instructions to connect the negative (-) battery cable at the engine crankcase.

3. **For V-Rod models only:** Install the air box aluminum cover per service manual instructions. **For ALL OTHER models:** Install the fuel tank per service manual instructions.
4. Install the handlebar cover, riser cover or outer fairing, if equipped, per service manual instructions.
5. Turn the ignition key switch to ON, but do not start the motorcycle. Test the Road Tech Zumo unit for proper operation.

▲ WARNING

After installing seat, pull upward on seat to be sure it is locked in position. While riding, a loose seat can shift causing loss of control, which could result in death or serious injury. (00070b)

6. Refer to the service manual, and follow instructions to close or install the seat.

SERVICE PARTS

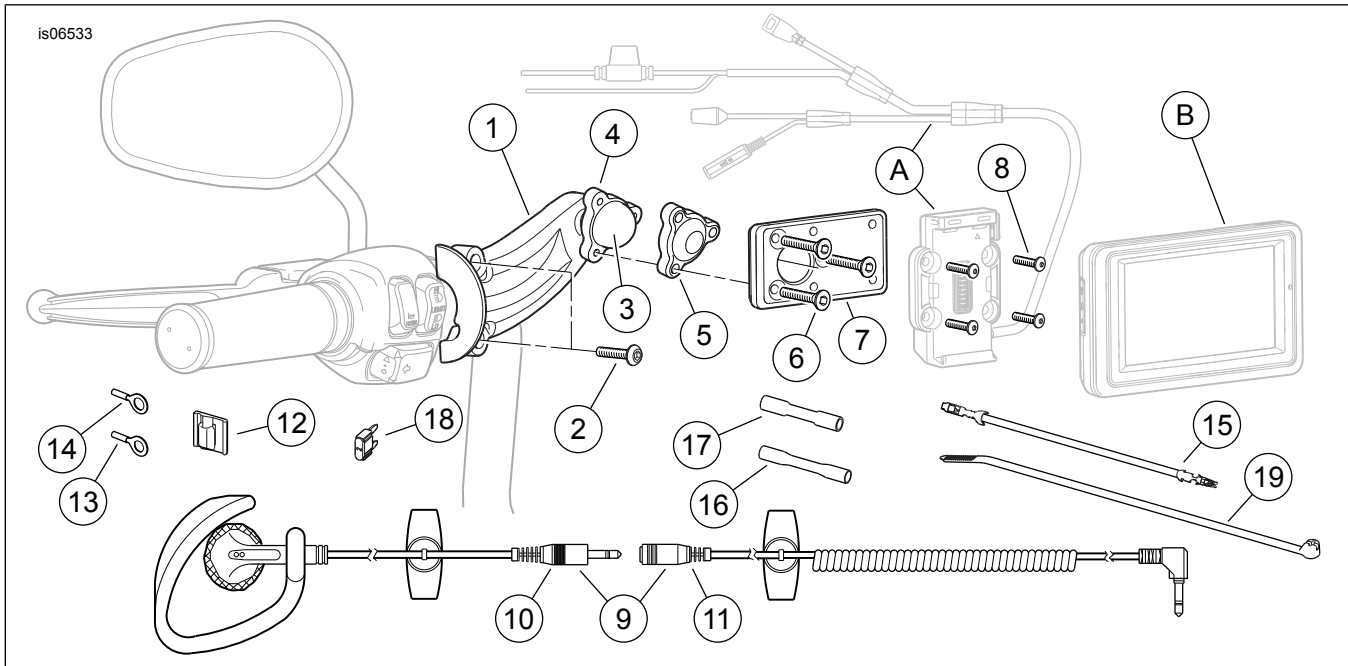

Figure 16. Service Parts, Road Tech Zumo 660 and Zumo 665 GPS Handlebar Mount Kit

Table 1. Service Parts

Item	Description (Quantity)	Part Number
1	Bracket, mounting, Road Tech Zumo 660/665 (chrome)	10865
2	Cap screw, button head, 1/4-20 x 28.6 mm (1 1/8 in) long (2)	4293
3	Mounting ball	Not sold separately
4	Ball clamp, lower	Not sold separately
5	Ball clamp, upper	Not sold separately
6	Screw, hex socket, flat head, #10-24 x 25 mm (1 in) long (3)	Not sold separately
7	Mounting plate, Zumo 660/665 GPS	Not sold separately
8	Screw, button head, M4 (4)	Not sold separately
9	Earphone Kit (includes items 10 and 11)	91771-04
10	• Earphone	Not sold separately
11	• Cable, extension	Not sold separately

Table 1. Service Parts

Item	Description (Quantity)	Part Number
12	Clip, adhesive-backed (3)	10271
13	Ring terminal, #18-22 AWG (1/4 inch stud)	9858
14	Ring terminal, #18-22 AWG (5/16 inch stud)	985
15	Fuse block adapter wire, orange/white	70329-04
16	Sealed splice connector, #18-20 AWG (red)	70585-93
17	Sealed splice connector, #14-16 AWG (blue)	70586-93
18	Fuse, blade type, 2A (2)	54305-98
19	Cable strap (10)	10006
Items mentioned in text, but not included in kit:		
A	Cradle mount, Zumo 660/665 GPS	
B	Zumo 660/665 GPS unit	