



INSTRUCTIONS

J05897

2013-06-17



CHROME AUXILIARY LAMP KIT

GENERAL

Kit Number

68000110

Models

For model fitment information, see the P&A Retail Catalog or the Parts and Accessories section of www.harley-davidson.com (English only).

Additional Parts Required

Auxiliary / fog lamps are not included in this kit. The desired style of lamp must be purchased separately. HDI (International) motorcycles should only use approved fog lamps.

Models with turn signals mounted on the upper or lower triple clamp will also require Front Directional Relocation Kit (Part No. 68603-01), available separately at any Harley-Davidson Dealer.

Separate purchase and installation of additional parts or accessories may be required for proper installation of this kit on your model motorcycle. See the P&A Retail Catalog or the Parts and Accessories section of www.harley-davidson.com (English only) for a list of required parts or accessories for your model.

⚠ WARNING

Rider and passenger safety depend upon the correct installation of this kit. Use the appropriate service manual procedures. If the procedure is not within your capabilities or you do not have the correct tools, have a Harley-Davidson dealer perform the installation. Improper installation of this kit could result in death or serious injury. (00333b)

NOTE

This instruction sheet references service manual information. A service manual for your model motorcycle is required for this installation and is available from a Harley-Davidson dealer.

Kit Contents

See Figure 7 and Table 1.

NOTICE

It is possible to overload the vehicle's charging system by adding too many electrical accessories. If the combined electrical accessories operating at any one time consume more electrical current than the vehicle's charging system can produce, the electrical consumption can discharge the battery and cause damage to the vehicle's electrical system. (00211d)

These lamps require 2.9 amps of available current from the motorcycle's electrical system.

INSTALLATION

⚠ WARNING

To prevent accidental vehicle start-up, which could cause death or serious injury, remove main fuse before proceeding. (00251b)

NOTE

For vehicles equipped with security siren:

- Verify that the Hands-Free Fob is present.
- Turn the ignition key switch to IGNITION.

1. Refer to the service manual and follow the instructions to remove the main fuse.

⚠ WARNING

Stop the engine when refueling or servicing the fuel system. Do not smoke or allow open flame or sparks near gasoline. Gasoline is extremely flammable and highly explosive, which could result in death or serious injury. (00002a)

2. Remove the fuel tank following the instructions in the service manual.
3. Access left side electrical caddy following the instructions in the service manual.

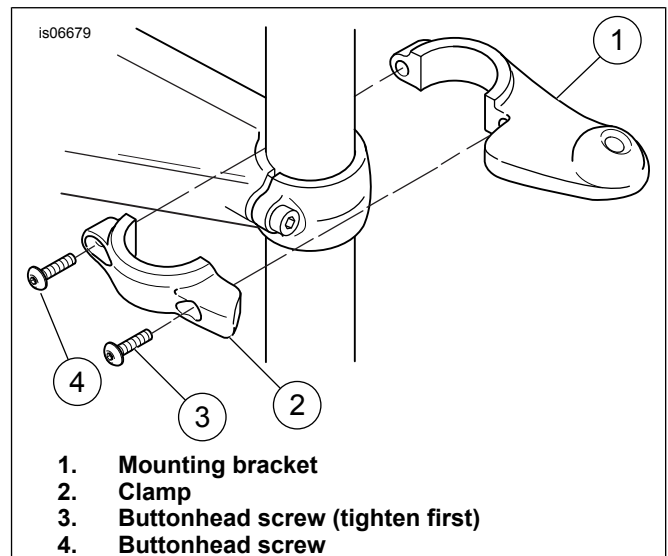

Figure 1. Install Mounting Bracket on Fork Tube (Right Side Shown)



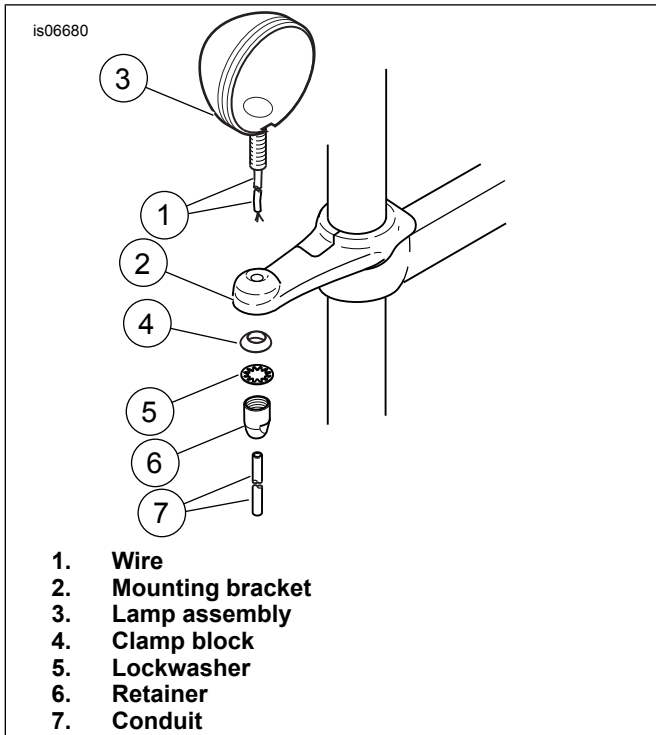

Figure 2. Install Lamps (Right Side Shown)

4. See Figure 1. The mounting brackets (1) and clamps (2) are side-specific. Select the right-hand or left-hand bracket and clamp, and install on the fork tube with two button-head screws (3 and 4) from the kit.
5. Starting with the outer screw (3), tighten to 8–9 N·m (70–80 in-lbs). Repeat for screw (4).
6. See Figure 2. Route the lamp wire (1) through the hole in the mounting bracket (2), and secure the lamp (3) to the bracket using a clamp block (4), lockwasher (5) and retainer (6) from the kit. Tighten the retainer to 16-18 ft-lbs (22-24 Nm).

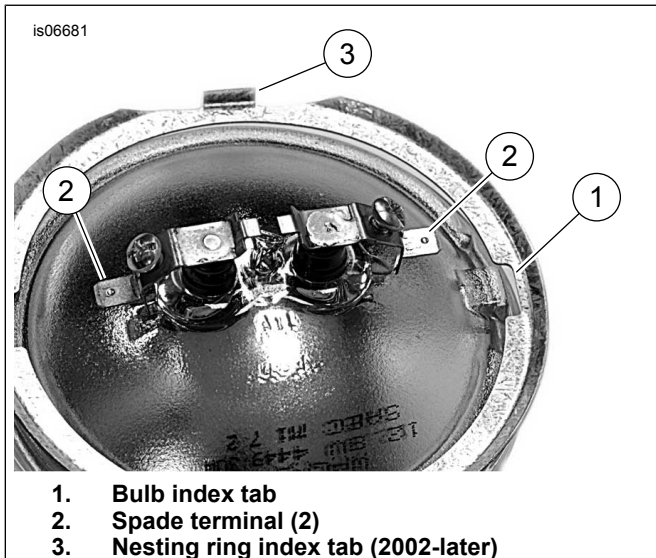

Figure 3. Auxiliary Lamp Bulb Terminals

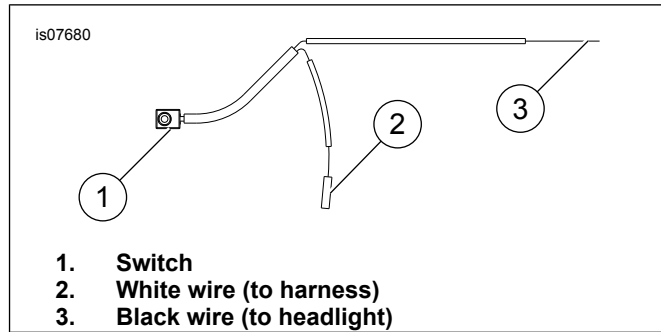

Figure 4. Kit Wiring Harness

7. See Figure 7. Locate the outer trim ring (24), inner nesting ring (27), screw (25), and nut (26).
8. See Figure 3. Place the inner nesting ring on the bulb. Connect the black wire to the bulb spade terminal next to the bulb indexing tab (1) on the bulb. Install the gray wire on the remaining spade terminal.
9. Attach the bulb and nesting ring using the trim ring, screw and nut.
10. See Figure 2. Slide the conduit (7) from the kit over the lamp wire.
11. Repeat Steps 3 through 9 for the opposite side.

NOTICE

When routing wires and harnesses, verify that they are clear of moving parts, heat sources and pinch points to avoid wire damage or a short circuit, which could result in electrical system damage. (00579b)

12. See Figure 4. Locate the headlamp connector [38] in left caddy and disconnect.
13. See Figure 7 and the connector appendix of the service manual. Install the white wire socket terminal of harness (14) into the empty cavity of the headlamp connector socket housing.
14. Connect the headlamp connector to the main harness.
15. See Figure 4. Route the harness past the steering head, and route the lamp switch (1) leg of the harness along the left side of the handlebar to the clutch control.
16. See Figure 7. Obtain the switch mounting bracket (19) from the kit. Remove the boot from the lamp switch, and install the switch into the bracket. Replace the boot on the switch.

NOTE

If the boot becomes worn or damaged, or is lost, replace the boot to prevent moisture from entering the switch. See Figure 7 (item 11).

17. See Figure 5. Remove the lower screw (1) and washer from the clutch control clamp, and install the lamp switch and bracket assembly (2). Install the screw and washer and tighten to 7–9 N·m (60–80 in-lbs). **For International Applications:** Place the fog lamp switch label (3) on the clutch control clamp.
18. See Figure 7. Secure the lamp switch leg of the harness to the handlebar using the wire harness retainers (Item 18) as needed. Snap the retainers into the holes in the handlebar.
19. Route the black unterminated wire (1) from the switch past the steering head toward the auxiliary lamps.

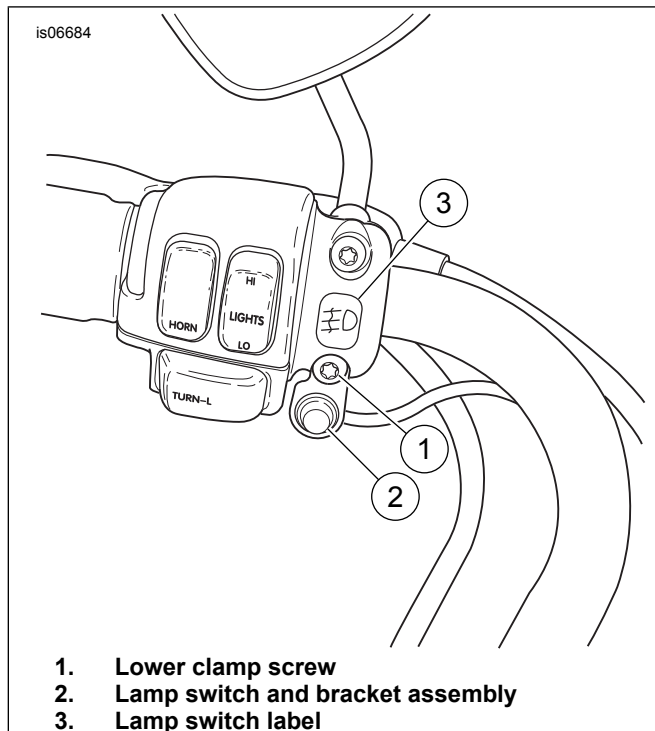

Figure 5. Install Lamp Switch (1996-later shown)

20. See Figure 6 connector appendix of the service manual. Slide the heat-shrink tubing over the black wire of the kit harness, and crimp the electrical connector to the wire with a Crimp Tool, Part No. H-D 38125-8.
21. Bring both lamp wires (4) to the connector. Trim the wires, allowing approximately 1 inch (25 mm) of the wire to extend past the butt splice connector. Trim the conduit (5) approximately 1-1/2 in. (38 mm) back from the end of the wire.
22. Remove approximately 3/8 in. (10 mm) of insulation from the end of the lamp wires.
23. Insert the ends of both lamp wires (4) into the electrical connector (3) and crimp the wires to the connector with the crimp tool.

NOTE

Protect the heat-shrink tubing from the heat source while applying heat to the electrical connector.

▲ WARNING

Be sure to follow manufacturer's instructions when using the UltraTorch UT-100 or any other radiant heating device. Failure to follow manufacturer's instructions can cause a fire, which could result in death or serious injury. (00335a)

24. Slide the heat-shrink tubing (1) away from the splice and using the UltraTorch UT-100 (H-D 39969), Robinair Heat Gun (H-D 25070) with Heatshrink Attachment (H-D 41183), or other suitable radiant heating device, heat the crimped splice to encapsulate the butt splice connection. Apply heat from the center of the crimp out to each end until the meltable sealant exudes out of both ends of the connector. Let the connector cool.

25. Slide the heat-shrink tubing back over the splice and using the same radiant heating device, heat the tubing to encapsulate the butt splice connection. Apply heat from the center of the tubing out to each end.

▲ WARNING

Be sure that steering is smooth and free without interference. Interference with steering could result in loss of vehicle control and death or serious injury. (00371a)

26. See Figure 7. Secure the wires to the lower fork steering bracket using the adhesive-backed clips (15) from the kit.
27. Install the fuel tank following the instructions in the service manual.
28. Connect the battery cables, positive cable first.

▲ WARNING

After installing seat, pull upward on seat to be sure it is locked in position. While riding, a loose seat can shift causing loss of control, which could result in death or serious injury. (00070b)

29. Refer to the service manual and follow instructions to install the seat.

▲ WARNING

The automatic-on headlamp feature provides increased visibility of the rider to other motorists. Be sure headlamp is on at all times. Poor visibility of rider to other motorists can result in death or serious injury. (00030b)

30. Test headlamp high and low beams, and the auxiliary lamps for proper operation. Aim the auxiliary lamps and tighten the lamp mounting nuts.

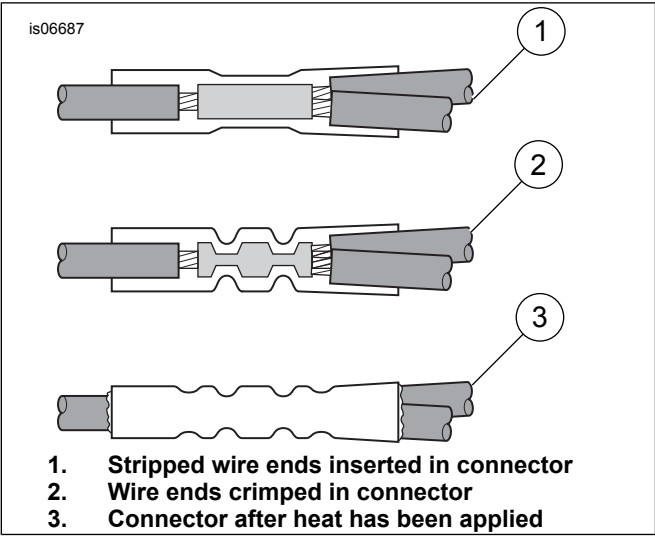

Figure 6. Installing Sealed Butt Splice Connectors

SERVICE PARTS

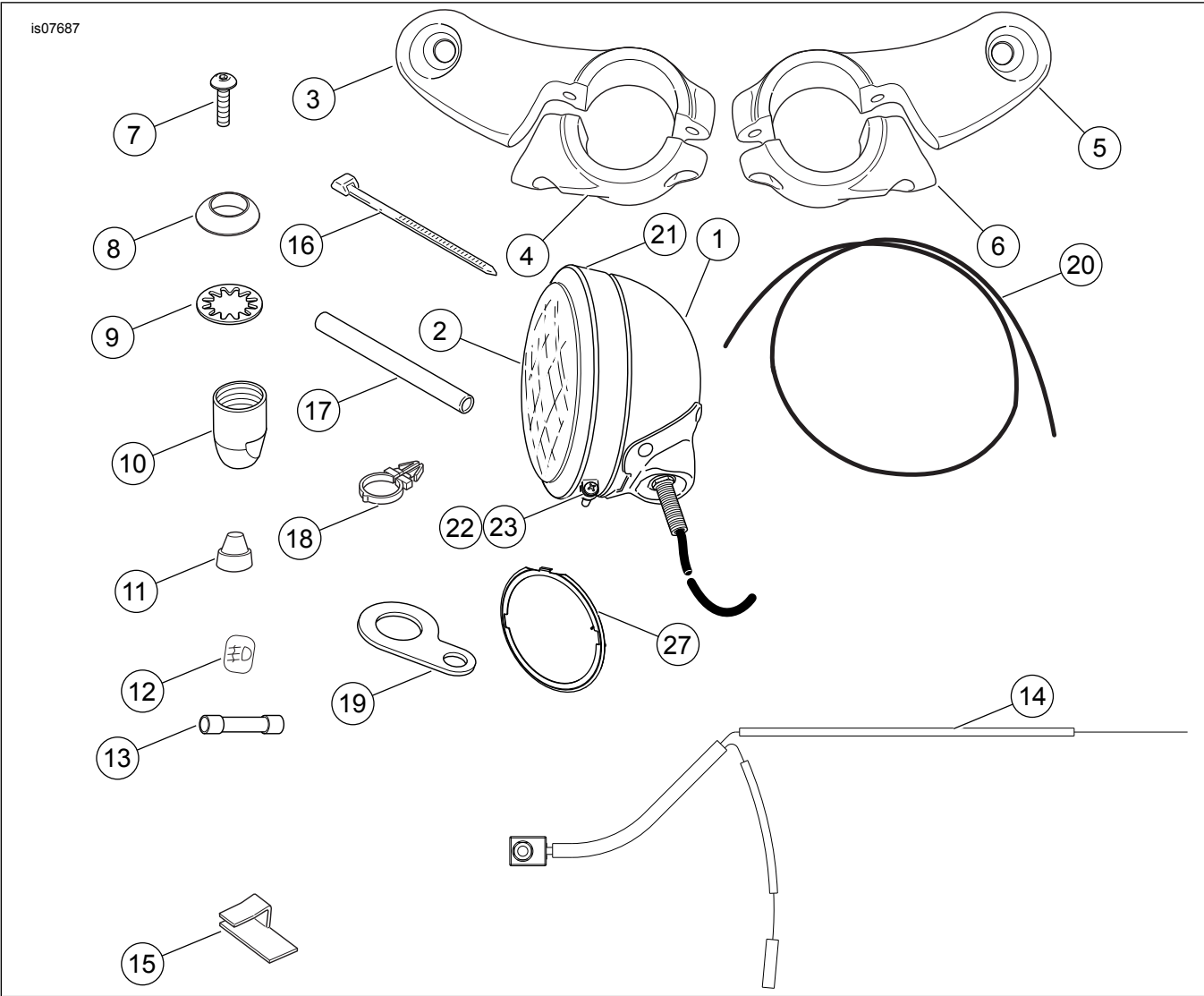

Figure 7. Service Parts: Auxiliary Light Kit

Table 1. Service Parts Table

Item	Description (Quantity)	Part Number
1	Passing lamp housing (2)	68276-02
2	Sealed unit (purchased separately)	
3	Bracket, lamp mounting (right)	Not Sold Separately
4	Clamp, lamp mounting (right)	Not Sold Separately
5	Bracket, lamp mounting (left)	Not Sold Separately
6	Bracket, lamp mounting (left)	Not Sold Separately
7	Screw, socket-head, 1/4-20 x 3/4 in, locking (4)	927A
8	Clamp block, auxiliary lamp (2)	68720-62
9	Lockwasher, internal tooth, 3/8 in. (2)	7130W
10	Retainer, lamp mounting (2)	Not Sold Separately
11	Boot, switch	67880-94
12	Label, lamp switch, HDI only	68604-01
13	Connector, pre-insulated, sealed, butt splice	70586-93
14	Wiring harness assembly	69200804
15	Clip, adhesive-backed (4)	10102
16	Cable strap, 7/8 in (198 mm) (12)	10102
17	Shrink tube	72266-94
18	Harness retainer (4)	70345-84
19	Bracket, switch mounting	Not Sold Separately
20	Conduit, vinyl, 15 in (38.1 cm) (2)	Not Sold Separately
21	Trim ring	68725-62A
22	Screw	3514
23	Nut	7606
24	Inner nesting ring	68331-02